

# Inductors / Coils EMI Suppression Filters

ARLITECH ELECTRONIC CORP.

<http://www.arlitech.com.tw>

## ARLITECH

今展科技股份有限公司  
ARLITECH ELECTRONIC CORP.

新北市三重區重新路五段646號14樓  
14F, NO. 646 SEC.5, CHUNG HSING RD., SANCHUNG DIST.,  
NEW TAIPEI CITY, TAIWAN  
TEL: 886-2-2999-8313  
FAX: 886-2-2995-7520  
E-mail: sales@arlitech.com.tw



ARLITECH ELECTRONIC CORP.  
2012 Products Catalog

今亞中電子貿易有限公司

華東分公司/蘇州市觀前街宮巷78號吳商會館3樓8302室  
TEL: 86-512-65812820  
FAX: 86-512-65812870  
華南分公司/深圳市福田區彩田路2010號中深花園A座27樓2709室  
TEL: 86-755-22387466  
FAX: 86-755-22387477

今耀電子有限公司

廣州市番禺區東浦鎮太石工業區博盈工業園6棟4-5樓  
TEL: 86-20-28689089  
FAX: 86-20-28689059

## ARLITECH

今展科技股份有限公司

2012. Jan

2012. Jan

<http://www.arlitech.com.tw>





## SMD Power Inductors

ATNR 3010, 4010, 4018, 5010, 5012, 6010, 6012, 6020, 8040 Series

page ..... 1-3

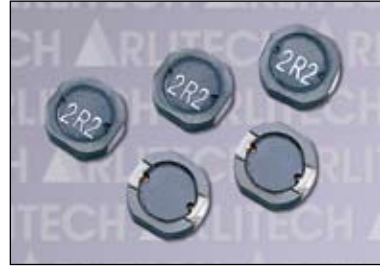

## SMD Power Inductors

ATOK 7032, 7045 Series

page ..... 18-19



## SMD Power Inductors

ATNR 5D20, 6D28 Series

page ..... 4-5



## SMD Power Inductors

ATOK 7016HL, 7020HL, 7025HL, 7032HL, 7045HL Series

page ..... 20-21



## SMD Power Inductors

ATNR 3010M, 3012M, 3015M, 4010M, 4012M, 4018M, 5010M, 6010M, 6012M, 6020M, 6045M, 8030M, 8040M, 8050M Series

page ..... 6-9



## SMD Power Inductors

AFPI 1003, 1004, 1005 Series

page ..... 22-23



## SMD Power Inductors

AGPI 3D11, 3D16, 4D18, 4D28, 5D18, 5D28, 6D28, 6D38, 8D43, 5012, 6012, 7D15, 7D18, 7D25, 7D28, 10D15, 10D25 Series

page ..... 10-16



## SMD Power Inductors

ASPI 1204, 1205, 1207 Series

page ..... 24-26



## SMD Power Inductors

AGPI 2D11A, 3D16A Series

page ..... 17



## SMD Power Inductors

ADPI 1207HL Series

page ..... 27





## SMD Power Inductors

AFOR 0645M Series

page ..... 28



## High Current Power Inductors

ADIP 1109EP Series

page ..... 42



## SMD Power Inductors

APIR 1608, 3216, 5022 Series

page ..... 29-30



## SMD Chip Inductors

AOI 1005C, 1608CN, 2012CN, 2520CN, 2012FN, 2520FN, 3225FN Series

page ..... 43-49



## SMD Power Inductors

APIW 1608, 3308, 3316, 3340, 5022 Series

page ..... 31-33



## SMD Chip Inductors

AOIC 1610N, 2012N, 2520N, 3225N, 1610D, 2012D Series

page ..... 50-53



## SMD Power Inductors

ATPI 0301, 0302, 0403, 0504, 0703, 0705, 1005 Series

page ..... 34-37



## SMD Chip Inductors

AQH 2520, 3225, 4532 Series

page ..... 54-56



## High Current Power Inductors

AMPI 0630BD, 0630ED, 0630GD, 1040BD, 1040EB, 1240BD, 1265BD, 1770BD, 1770ED Series

page ..... 38-41



## EMI Suppression Filter

ATCM 2012, 3216 Series

page ..... 57-58

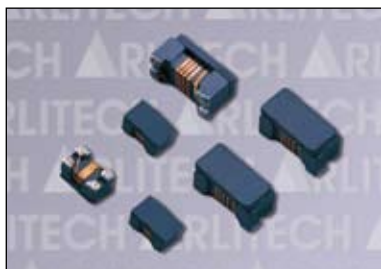

## EMI Suppression Filter

ATCM 2012DB, 2012HB  
(for HDMI) Series

page ..... 59-60



## SMD Chip Inductors

AIG 1608, 2012, 3216  
Series

page ..... 79-81



## SMD Chip Inductors

AWI 2520, 3225, 4532  
Series

page ..... 61-63



## SMD Chip Inductors

AIF 1005, 1608, 2012  
Series

page ..... 82-84



## EMI Suppression Filter

AMB 1005, 1608, 2012,  
3216 Series

page ..... 64-74



## DIP Inductors

ADR 0608, 0810, 0912  
Series

page ..... 85-86



## EMI Suppression Filter

AMC 1005, 1608, 2012  
Series

page ..... 75-76



## EMI Suppression Filter

AMA 3216 Series

page ..... 77-78

**Features**

- Small and Low profile inductor.
- High current performance.
- High magnetic shield construction should actualize high resolution.
- Available for automatic mounting in tape and reel package

**Applications**

The ATNR series sre characterized by low profile, and high current power inductor use in cellular Phone, HDD, DVC, DSC, PDA, LCD display, and other electronic equipment. Several dimensions are available.

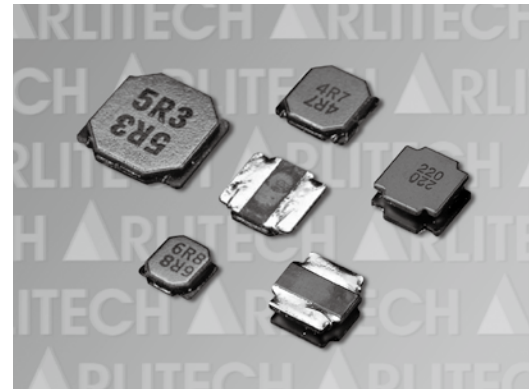

**Shape & Dimensions**

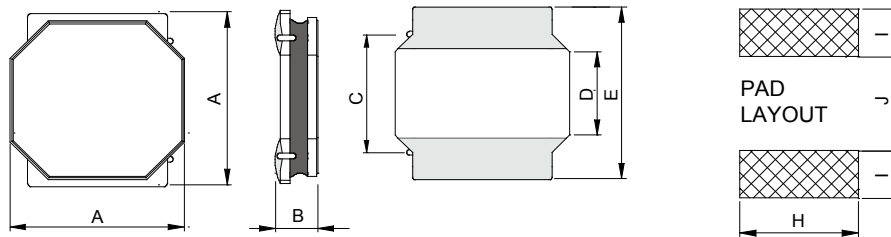

TYPE	A (mm)	B (mm)	C (mm)	D (mm)	E (mm)	H (Ref.)	I (Ref.)	J (Ref.)
ATNR3010	3.0±0.2	0.9±0.1	2.0±0.2	1.0±0.2	3.0±0.2	2.7	0.8	1.4
ATNR4010	4.0±0.2	0.9±0.1	2.7±0.2	1.4±0.2	4.0±0.2	3.7	1.2	1.6
ATNR4018	4.0±0.2	1.8 MAX.	2.7±0.2	1.4±0.2	4.0±0.2	3.7	1.2	1.6
ATNR5010	5.0±0.2	0.9±0.1	3.5±0.2	2.0±0.2	5.0±0.2	4.7	1.4	2.4
ATNR5012	5.0±0.2	1.1±0.1	3.5±0.2	2.0±0.2	5.0±0.2	4.7	1.4	2.4
ATNR6010	6.0±0.2	0.9±0.1	4.325±0.2	2.65±0.2	6.0±0.2	5.7	1.6	3.1
ATNR6012	6.0±0.2	1.1±0.1	4.325±0.2	2.65±0.2	6.0±0.2	5.7	1.6	3.1
ATNR6020	6.0±0.2	2.0 MAX.	4.325±0.2	2.65±0.2	6.0±0.2	5.7	1.6	3.1

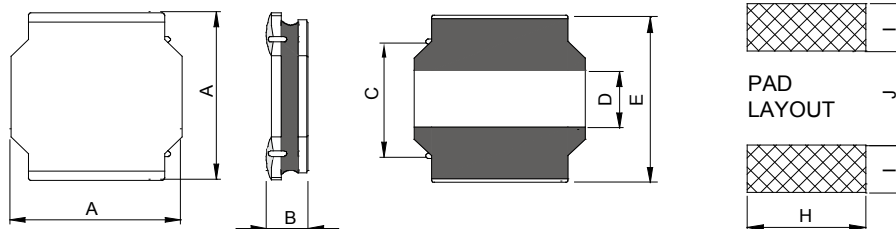

TYPE	A (mm)	B (mm)	C (mm)	D (mm)	E (mm)	H (Ref.)	I (Ref.)	J (Ref.)
ATNR8040	8.0±0.2	*1 4.2 MAX.	5.6±0.2	3.9±0.2	8.0±0.2	7.7	1.8	3.8
ATNR8040	8.0±0.2	*2 4.0 MAX.	5.6±0.2	3.9±0.2	8.0±0.2	7.7	1.8	3.8

(\*1) OR9~100=4.2 MAX. / (\*2) 120~ =4.0 MAX.

## Product Identification

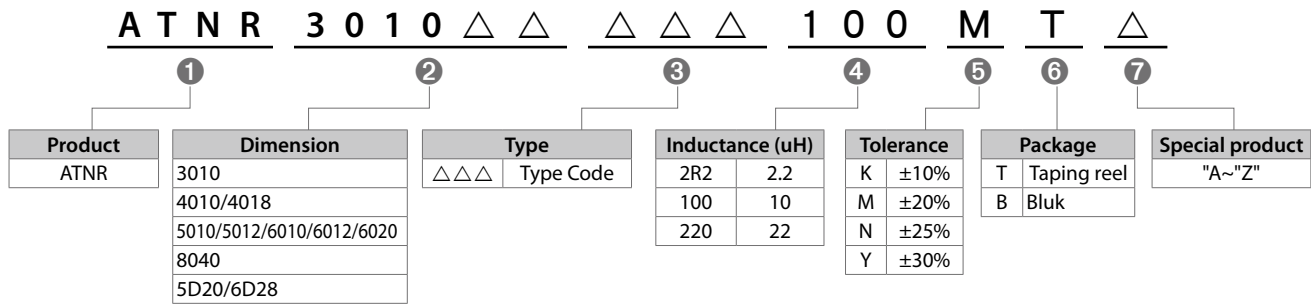

## Specification

Part Number	Inductance (H)	Test Freq. (Hz)	DCR (mΩ) Max.	Saturation Current (A) Max.	Temp. Rise current (A) Max.
<b>ATNR3010 Series Specification</b>					
ATNR30102R2□T	2.2u	100 K	160	1.3	1.3
ATNR30103R3□T	3.3u	100 K	220	1.2	1.0
ATNR30104R7□T	4.7u	100 K	360	1.1	0.9
ATNR30106R8□T	6.8u	100 K	450	0.9	0.8
ATNR30108R2□T	8.2u	100 K	490	0.7	0.7
ATNR3010100□T	10u	100 K	590	0.6	0.51
<b>ATNR4010 Series Specification</b>					
ATNR40102R2□T	2.2u	100 K	143	1.6	1.4
ATNR40103R3□T	3.3u	100 K	197	1.4	1.35
ATNR40104R7□T	4.7u	100 K	270	1.3	1.3
ATNR40106R8□T	6.8u	100 K	360	1.0	1.0
ATNR40108R2□T	8.2u	100 K	396	0.9	0.9
ATNR4010100□T	10u	100 K	480	0.8	0.8
<b>ATNR4018 Series Specification</b>					
ATNR40182R2□T	2.2u	100 K	90	2.8	2.3
ATNR40183R3□T	3.3u	100 K	110	2.6	1.8
ATNR40184R7□T	4.7u	100 K	150	2.2	1.7
ATNR40186R8□T	6.8u	100 K	220	1.8	1.2
ATNR4018100□T	10u	100 K	345	1.4	0.9
<b>ATNR5010 Series Specification</b>					
ATNR50102R2□T	2.2u	100 K	135	1.8	1.4
ATNR50103R3□T	3.3u	100 K	160	1.4	1.2
ATNR50104R7□T	4.7u	100 K	230	1.3	1.0
ATNR50106R8□T	6.8u	100 K	265	1.0	0.8
ATNR5010100□T	10u	100 K	420	0.9	0.7
<b>ATNR5012 Series Specification</b>					
ATNR50122R2□T	2.2u	100 K	105	2.6	2.2
ATNR50123R3□T	3.3u	100 K	155	2.1	1.9
ATNR50124R7□T	4.7u	100 K	195	1.6	1.5
ATNR50126R8□T	6.8u	100 K	295	1.3	1.2
ATNR5012100□T	10u	100 K	410	1.1	1.0

### NOTE:

- The operating temperature range is -25°C to +120°C
- Isat: For Inductance drop 30% from its value without current.
- □ Tolerance: M:  $\pm 20\%$ , N:  $\pm 25\%$ , Y:  $\pm 30\%$
- Irms: The value of D.C current when the temperature rise is  $\Delta T \leq 40^\circ\text{C}$ . ( $T_a = 25^\circ\text{C}$ )

### Specification

Part Number	Inductance (H)	Test Freq. (Hz)	DCR (mΩ) Max.	Saturation Current (A) Max.	Temp. Rise current (A) Max.
<b>ATNR6010 Series Specification</b>					
ATNR60102R2□T	2.2u	100 K	155	2.20	1.90
ATNR60103R3□T	3.3u	100 K	205	1.90	1.60
ATNR60104R7□T	4.7u	100 K	277	1.65	1.50
ATNR60106R8□T	6.8u	100 K	450	1.60	1.22
ATNR60108R2□T	8.2u	100 K	390	1.20	1.21
ATNR6010100□T	10u	100 K	400	1.4(Ref.)	1.20
<b>ATNR6012 Series Specification</b>					
ATNR60122R2□T	2.2u	100 K	120	2.60	2.10
ATNR60123R3□T	3.3u	100 K	175	2.15	1.70
ATNR60124R7□T	4.7u	100 K	220	1.85	1.50
ATNR60125R3□T	5.3u	100 K	240	1.70	1.60
ATNR60126R8□T	6.8u	100 K	280	1.60	1.20
ATNR60128R2□T	8.2u	100 K	320	1.45	1.15
ATNR6012100□TB	10u	100 K	430	1.40	1.10
<b>ATNR6020 Series Specification</b>					
ATNR60202R2□T	2.2u	100 K	55	4.0	2.9
ATNR60203R3□T	3.3u	100 K	75	3.2	2.5
ATNR60204R7□T	4.7u	100 K	90	2.8	2.4
ATNR60206R8□T	6.8u	100 K	115	2.4	2.1
ATNR6020100□T	10u	100 K	175	1.9	1.6
<b>ATNR8040 Series Specification</b>					
ATNR80401R5□TA	1.5u	100 K	15	9.0	8.0
ATNR80402R2□TA	2.2u	100 K	18	7.5	7.0
ATNR80403R3□TA	3.3u	100 K	20	6.5	6.0
ATNR80404R7□T	4.7u	100 K	31	5.5	4.1
ATNR80406R8□TA	6.8u	100 K	35	5.0	5.0
ATNR8040100□T	10u	100 K	54	4.0	3.0
ATNR8040150□T	15u	100 K	85	2.5	2.4
ATNR8040220□T	22u	100 K	104	2.6	2.0

#### NOTE:

- The operating temperature range is -25°C to +120°C
- Isat: For Inductance drop 30% from its value without current.
- □ Tolerance M: ±20%, N: ±25%, Y: ±30%
- Irms: The value of D.C current when the temperature rise is  $\Delta T \leq 40^\circ\text{C}$ . ( $T_a = 25^\circ\text{C}$ )



**Features**

- Small and Low profile inductor.
- High current performance.
- High magnetic shield construction should actualize high resolution.
- Available for automatic mounting in tape and reel package

**Applications**

The ATNR series sre characterized by low profile, and high current power inductor use in cellular Phone, HDD, DVC, DSC, PDA, LCD display, and other electronic equipment. Several dimensions are available.



**Shape & Dimensions**

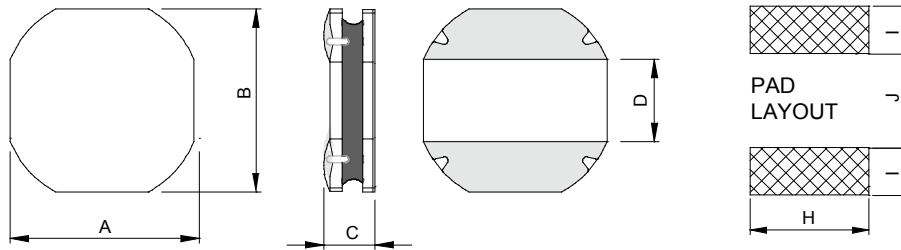

TYPE	A (mm)	B (mm)	C (mm)	D (mm)	H (Ref.)	I (Ref.)	J (Ref.)
ATNR5D20	5.0±0.2	4.8±0.2	2.0 MAX.	2.0 REF.	4.7	1.4	2.4
ATNR6D28	6.0±0.2	5.9±0.2	2.8 MAX.	2.8 TYP.	5.7	1.6	2.8

**Product Identification**

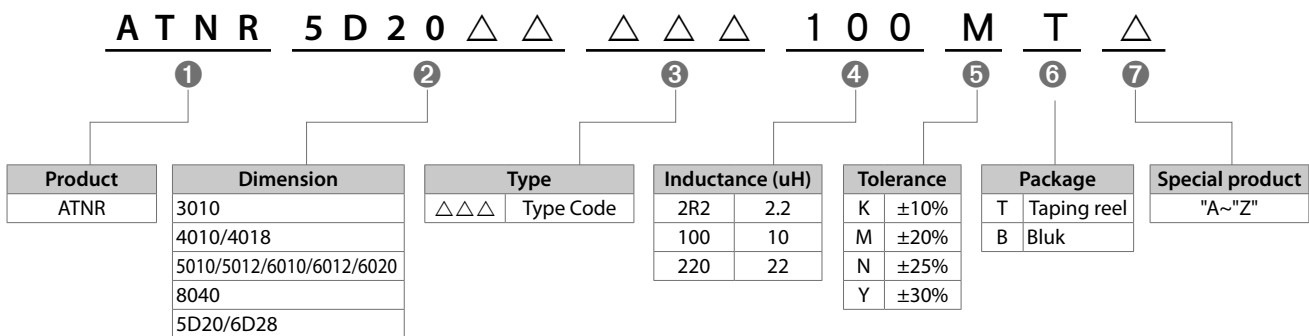



### Specification

Part Number	Inductance (H)	Test Freq. (Hz)	DCR (mΩ) Max.	Saturation Current (A) Max.	Temp. Rise current (A) Max.
<b>ATNR5D20 Series Specification</b>					
ATNR5D201R0□T	1.0u	100 K	43	5.5	4.0
ATNR5D202R2□T	2.2u	100 K	130	3.2	2.15
ATNR5D203R3□T	3.3u	100 K	150	3.0	2.1
ATNR5D204R7□T	4.7u	100 K	176	2.5	1.9
ATNR5D206R8□T	6.8u	100 K	235	2.2	1.7
ATNR5D20100□T	10u	100 K	352	1.8	1.3
ATNR5D20150□T	15u	100 K	492	1.4	1.0
ATNR5D20220□T	22u	100 K	800	1.1	0.8
<b>ATNR6D28 Series Specification</b>					
ATNR6D282R2□T	2.2u	100 K	62	8.00	3.00
ATNR6D283R3□T	3.3u	100 K	78	6.36	2.70
ATNR6D284R7□T	4.7u	100 K	115	5.00	2.30
ATNR6D286R8□T	6.8u	100 K	150	4.33	1.95
ATNR6D28100□T	10u	100 K	210	3.49	1.65
ATNR6D28150□T	15u	100 K	360	3.30	1.30
ATNR6D28220□T	22u	100 K	450	2.90	1.20

#### NOTE:

- The operating temperature range is -25°C to +120°C
- Isat: For Inductance drop 30% from its value without current.
- □ Tolerance M: ±20%, N: ±25%, Y:±30%
- I<sub>rms</sub>: The value of D.C current when the temperature rise is  $\Delta T \leq 40^\circ\text{C}$ . (T<sub>a</sub>=25°C)

**Features**

- Small and Low profile inductor.
- High current performance.
- High magnetic shield construction should actualize high resolution.
- Available for automatic mounting in tape and reel package

**Applications**

The ATNR M series sre characterized by low profile, and high current power inductor use in cellular Phone, HDD, DVC, DSC, PDA, LCD display, and other electronic equipment. Several dimensions are available.

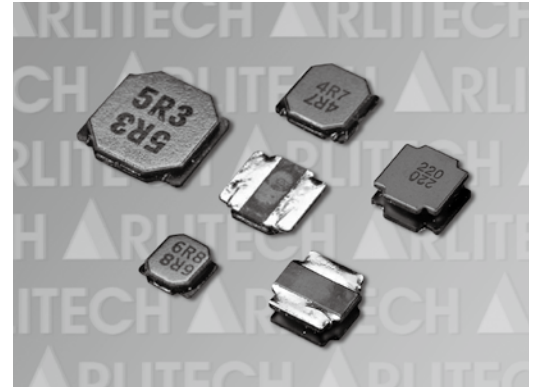

**Shape & Dimensions**

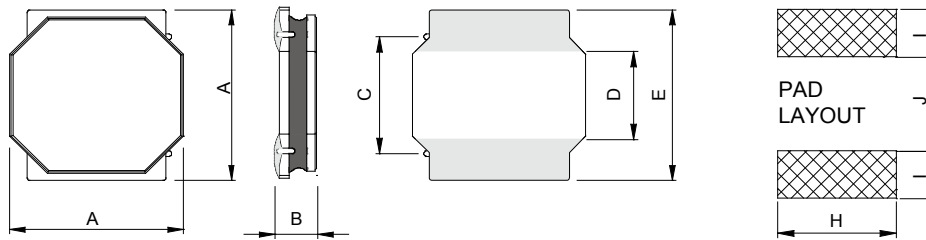

TYPE	A (mm)	B (mm)	C (mm)	D (mm)	E (mm)	H (Ref.)	I (Ref.)	J (Ref.)
ATNR3010M	3.0±0.2	0.9±0.1	2.0±0.2	1.0±0.2	3.0±0.2	2.7	0.8	1.4
ATNR3012M	3.0±0.2	1.1±0.1	2.0±0.2	1.0±0.2	3.0±0.2	2.7	0.8	1.4
ATNR3015M	3.0±0.2	1.5 MAX.	2.0±0.2	1.0±0.2	3.0±0.2	2.7	0.8	1.4
ATNR4010M	4.0±0.2	0.9±0.1	2.7±0.2	1.4±0.2	4.0±0.2	3.7	1.2	1.6
ATNR4012M	4.0±0.2	1.1±0.1	2.7±0.2	1.4±0.2	4.0±0.2	3.7	1.2	1.6
ATNR4018M	4.0±0.2	1.8 MAX.	2.7±0.2	1.4±0.2	4.0±0.2	3.7	1.2	1.6
ATNR5010M	5.0±0.2	0.9±0.1	3.5±0.2	2.0±0.2	5.0±0.2	4.7	1.4	2.4
ATNR6010M	6.0±0.2	0.9±0.1	4.325±0.2	2.65±0.2	6.0±0.2	5.7	1.6	3.1
ATNR6012M	6.0±0.2	1.1±0.1	4.325±0.2	2.65±0.2	6.0±0.2	5.7	1.6	3.1
ATNR6020M	6.0±0.2	2.0 MAX.	4.325±0.2	2.65±0.2	6.0±0.2	5.7	1.6	3.1
ATNR6045M	6.0±0.2	4.5 MAX.	4.325±0.2	2.65±0.2	6.0±0.2	5.7	1.6	3.1

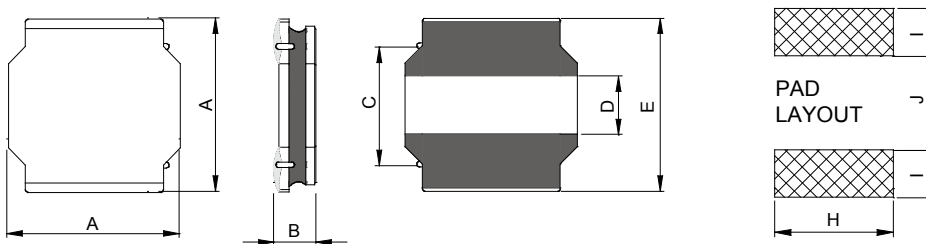

TYPE	A (mm)	B (mm)	C (mm)	D (mm)	E (mm)	H (Ref.)	I (Ref.)	J (Ref.)
ATNR8030M	8.0±0.2	3.0 MAX.	5.6±0.2	3.9±0.2	8.0±0.2	7.7	1.8	3.8
ATNR8040M	8.0±0.2	*1 4.2 MAX.	5.6±0.2	3.9±0.2	8.0±0.2	7.7	1.8	3.8
ATNR8040M	8.0±0.2	*2 4.0 MAX.	5.6±0.2	3.9±0.2	8.0±0.2	7.7	1.8	3.8
ATNR8050M	8.0±0.2	5.0 MAX.	5.6±0.2	3.9±0.2	8.0±0.2	7.7	1.8	3.8

(\*1) 0R9~100=4.2 MAX. / (\*2) 120~ =4.0 MAX.

## Product Identification

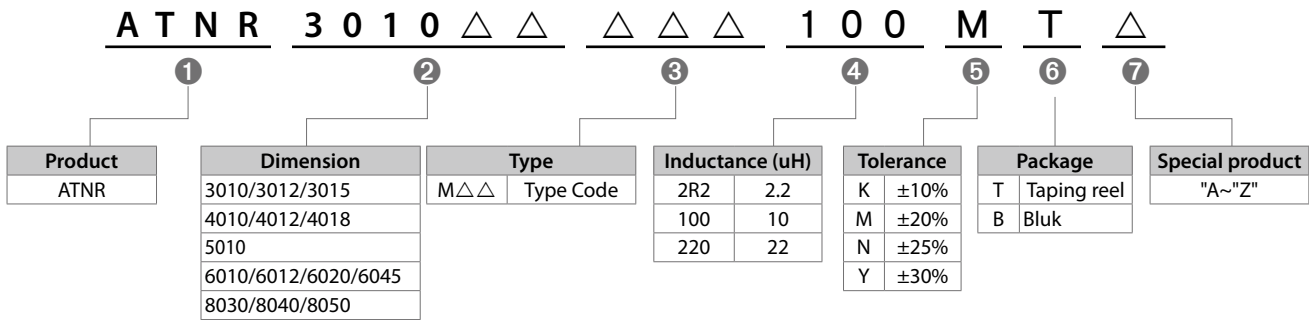

## Specification

Part Number	Inductance (H)	Test Freq. (Hz)	DCR (mΩ) Max.	Saturation Current (A) Max.	Temp. Rise current (A) Max.
<b>ATNR3010M Series Specification</b>					
ATNR3010M1R2□T	1.2u	100 K	78	1.700	1.480
ATNR3010M1R5□T	1.5u	100 K	90	1.440	1.370
ATNR3010M2R2□T	2.2u	100 K	99.6	1.300	1.300
ATNR3010M3R3□T	3.3u	100 K	156	1.000	1.030
ATNR3010M4R7□T	4.7u	100 K	204	0.850	0.900
ATNR3010M6R8□T	6.8u	100 K	300	0.700	0.745
ATNR3010M100□T	10u	100 K	420	0.600	0.620
ATNR3010M150□T	15u	100 K	660	0.450	0.480
ATNR3010M220□T	22u	100 K	924	0.380	0.410
<b>ATNR3012M Series Specification</b>					
ATNR3012M1R0□T	1.0u	100 K	60	1.500	1.490
ATNR3012M1R5□T	1.5u	100 K	72	1.360	1.400
ATNR3012M2R2□T	2.2u	100 K	96	1.100	1.200
ATNR3012M3R3□T	3.3u	100 K	120	0.910	1.050
ATNR3012M4R7□T	4.7u	100 K	156	0.770	0.980
ATNR3012M6R8□T	6.8u	100 K	228	0.650	0.740
ATNR3012M100□T	10u	100 K	348	0.540	0.630
ATNR3012M150□T	15u	100 K	540	0.440	0.485
ATNR3012M220□T	22u	100 K	756	0.375	0.420
ATNR3012M330□T	33u	100 K	1236	0.510	0.330
ATNR3012M470□T	47u	100 K	1740	0.250	0.280
<b>ATNR3015M Series Specification</b>					
ATNR3015M1R0□T	1.0u	100 K	36	2.10	2.10
ATNR3015M1R5□T	1.5u	100 K	48	1.80	1.82
ATNR3015M2R2□T	2.2u	100 K	72	1.48	1.50
ATNR3015M3R3□T	3.3u	100 K	96	1.21	1.23
ATNR3015M4R7□T	4.7u	100 K	144	1.02	1.04
ATNR3015M6R8□T	6.8u	100 K	192	0.87	0.88
ATNR3015M100□T	10u	100 K	276	0.70	0.71
ATNR3015M150□T	15u	100 K	432	0.56	0.56
ATNR3015M220□T	22u	100 K	624	0.47	0.47
ATNR3015M330□T	33u	100 K	1008	0.39	0.37
ATNR3015M470□T	47u	100 K	1608	0.32	0.30
<b>ATNR4010M Series Specification</b>					
ATNR4010M1R0□T	1.0u	100 K	120	1.80	1.05
ATNR4010M2R2□T	2.2u	100 K	180	1.15	0.89
ATNR4010M3R3□T	3.3u	100 K	216	1.10	0.82
ATNR4010M4R7□T	4.7u	100 K	252	0.90	0.75
ATNR4010M6R8□T	6.8u	100 K	360	0.74	0.62
ATNR4010M100□T	10u	100 K	456	0.56	0.60
ATNR4010M150□T	15u	100 K	612	0.47	0.51
ATNR4010M220□T	22u	100 K	1044	0.36	0.40
ATNR4010M330□T	33u	100K	1848	0.28	0.30
ATNR4010M470□T	47u	100K	2172	0.24	0.28

### NOTE:

- The operating temperature range is -25°C to +120°C
- Isat: For Inductance drop 30% from its value without current.
- □ Tolerance M: ±20%, N: ±25%, Y: ±30%
- Irms: The value of D.C current when the temperature rise is  $\Delta T \leq 40^\circ\text{C}$ . ( $T_a = 25^\circ\text{C}$ )

### Specification

Part Number	Inductance (H)	Test Freq. (Hz)	DCR (mΩ) Max.	Saturation Current (A) Max.	Temp. Rise current (A) Max.
<b>ATNR4012M Series Specification</b>					
ATNR4012M1R0□T	1.0u	100 K	72	2.50	1.50
ATNR4012M2R2□T	2.2u	100 K	108	1.65	1.20
ATNR4012M3R3□T	3.3u	100 K	156	1.20	0.98
ATNR4012M4R7□T	4.7u	100 K	168	1.05	0.96
ATNR4012M6R8□T	6.8u	100 K	216	0.90	0.84
ATNR4012M100□T	10u	100 K	288	0.74	0.77
ATNR4012M150□T	15u	100 K	480	0.56	0.60
ATNR4012M220□T	22u	100 K	576	0.51	0.54
ATNR4012M330□T	33u	100 K	972	0.40	0.42
ATNR4012M470□T	47u	100 K	1200	0.35	0.37
<b>ATNR4018M Series Specification</b>					
ATNR4018M1R0□T	1.0u	100 K	32.4	4.00	3.20
ATNR4018M2R2□T	2.2u	100 K	50.4	3.00	2.20
ATNR4018M3R3□T	3.3u	100 K	66	2.30	2.00
ATNR4018M4R7□T	4.7u	100 K	84	2.00	1.70
ATNR4018M6R8□T	6.8u	100 K	117.6	1.60	1.45
ATNR4018M100□T	10u	100 K	180	1.30	1.20
ATNR4018M150□T	15u	100 K	252	1.10	0.85
ATNR4018M220□T	22u	100 K	348	0.90	0.72
ATNR4018M330□T	33u	100 K	552	0.70	0.55
<b>ATNR5010M Series Specification</b>					
ATNR5010M1R0□T	1.0u	100 K	50	2.20	2.20
ATNR5010M1R5□T	1.5u	100 K	65	1.70	2.15
ATNR5010M2R2□T	2.2u	100 K	85	1.40	1.70
ATNR5010M3R3□T	3.3u	100 K	102	1.10	1.40
ATNR5010M4R7□T	4.7u	100 K	136	1.00	1.15
ATNR5010M6R8□T	6.8u	100 K	183	0.85	1.00
ATNR5010M100□T	10u	100 K	236	0.65	0.85
ATNR5010M150□T	15u	100 K	402	0.55	0.65
<b>ATNR6010M Series Specification</b>					
ATNR6010M1R5□T	1.5u	100 K	100	2.40	1.90
ATNR6010M2R2□T	2.2u	100 K	120	1.90	1.70
ATNR6010M3R3□T	3.3u	100 K	135	1.60	1.50
ATNR6010M4R7□T	4.7u	100 K	165	1.30	1.40
ATNR6010M6R8□T	6.8u	100 K	260	1.20	1.20
ATNR6010M100□T	10u	100 K	300	1.00	1.10
ATNR6010M220□T	22u	100 K	670	0.65	0.70
<b>ATNR6012M Series Specification</b>					
ATNR6012M2R5□T	2.5u	100 K	110	2.10	1.73
ATNR6012M3R3□T	3.3u	100 K	125	1.80	1.65
ATNR6012M4R7□T	4.7u	100 K	155	1.60	1.55
ATNR6012M5R3□T	5.3u	100 K	160	1.50	1.40
ATNR6012M6R8□T	6.8u	100 K	165	1.30	1.18
ATNR6012M100□T	10u	100 K	250	1.00	1.00
ATNR6012M150□T	15u	100 K	355	0.80	0.79
ATNR6012M220□T	22u	100 K	530	0.76	0.63
ATNR6012M330□T	33u	100 K	780	0.59	0.53
ATNR6012M470□T	47u	100 K	1110	0.52	0.46
ATNR6012M680□T	68u	100 K	1440	0.44	0.41
ATNR6012M101□ T	100u	100 K	2190	0.35	0.32

#### NOTE:

- The operating temperature range is -25°C to +120°C
- Isat: For Inductance drop 30% from its value without current.
- □ Tolerance M: ±20%, N: ±25%, Y: ±30%
- Irms: The value of D.C current when the temperature rise is  $\Delta T \leq 40^\circ\text{C}$ . (Ta=25°C)



### Specification

Part Number	Inductance (H)	Test Freq. (Hz)	DCR (mΩ) Max.	Saturation Current (A) Max.	Temp. Rise current (A) Max.
<b>ATNR6020M Series Specification</b>					
ATNR6020M0R8□T	0.8u	100 K	24	5.50	3.80
ATNR6020M1R5□T	1.5u	100 K	31.2	4.00	3.20
ATNR6020M2R2□T	2.2u	100 K	40.8	3.20	2.70
ATNR6020M3R3□T	3.3u	100 K	48	2.80	2.60
ATNR6020M4R7□T	4.7u	100 K	67.2	2.40	2.00
ATNR6020M6R8□T	6.8u	100 K	102	2.00	1.80
ATNR6020M100□T	10u	100 K	150	1.60	1.40
ATNR6020M220□T	22u	100 K	348	1.05	0.95
<b>ATNR6045M Series Specification</b>					
ATNR6045M1R0□T	1.0u	100 K	19	8.50	4.20
ATNR6045M1R3□T	1.3u	100 K	21	8.00	4.00
ATNR6045M1R8□T	1.8u	100 K	23	7.00	3.70
ATNR6045M2R2□T	2.2u	100 K	27	6.00	3.50
ATNR6045M3R3□T	3.3u	100 K	31	5.00	3.20
ATNR6045M4R7□T	4.7u	100 K	41	4.00	3.00
ATNR6045M6R8□T	6.8u	100 K	52	3.60	2.60
ATNR6045M100□T	10u	100 K	61	3.00	2.50
ATNR6045M150□T	15u	100 K	100	2.30	1.90
ATNR6045M220□T	22u	100 K	149	1.90	1.50
ATNR6045M330□T	33u	100 K	210	1.50	1.40
ATNR6045M470□T	47u	100 K	286	1.30	1.10
ATNR6045M680□T	68u	100 K	429	1.00	0.90
ATNR6045M101□T	100u	100 K	650	0.80	0.70
<b>ATNR8030M Series Specification</b>					
ATNR8030M4R7□T	4.7u	100 K	30	4.65	4.00
ATNR8030M6R8□T	6.8u	100 K	35	3.84	3.60
ATNR8030M100□T	10u	100 K	59	3.18	2.80
ATNR8030M150□T	15u	100 K	91	2.30	2.20
ATNR8030M220□T	22u	100 K	143	1.90	1.90
ATNR8030M330□T	33u	100 K	202	1.74	1.35
ATNR8030M470□T	47u	100K	299	1.43	1.20
<b>ATNR8040M Series Specification</b>					
ATNR8040M0R9□T	0.9u	100 K	7.8	11.00	7.80
ATNR8040M1R4□T	1.4u	100 K	9.1	9.00	7.00
ATNR8040M2R0□T	2.0u	100 K	11.7	7.40	6.30
ATNR8040M3R6□T	3.6u	100 K	19.5	5.30	4.90
ATNR8040M4R7□T	4.7u	100 K	23.4	4.70	4.10
ATNR8040M6R8□T	6.8u	100 K	32.5	4.00	3.70
ATNR8040M100□T	10u	100 K	44.2	3.40	3.10
ATNR8040M150□T	15u	100 K	65	2.70	2.40
ATNR8040M220□T	22u	100 K	85.6	2.40	2.20
ATNR8040M330□T	33u	100 K	130	1.90	1.70
ATNR8040M470□T	47u	100 K	195	1.50	1.40
ATNR8040M680□T	68u	100 K	299	1.20	1.10
ATNR8040M101□T	100u	100 K	377	1.00	1.00
<b>ATNR8050M Series Specification</b>					
ATNR8050M4R7□T	4.7u	100 K	20	6.10	6.40
ATNR8050M6R8□T	6.8u	100 K	26	5.40	5.40
ATNR8050M100□T	10u	100 K	34	4.50	4.45
ATNR8050M150□T	15u	100 K	51	3.40	3.60
ATNR8050M220□T	22u	100 K	75	2.95	2.90
ATNR8050M270□T	27u	100 K	88	2.60	2.70
ATNR8050M330□T	33u	100 K	95	2.50	2.40
ATNR8050M470□T	47u	100K	130	2.00	2.00

#### NOTE:

- The operating temperature range is -25°C to +120°C
- Isat: For Inductance drop 30% from its value without current.
- □ Tolerance: M: ±20%, N: ±25%, Y: ±30%
- Irms: The value of D.C current when the temperature rise is  $\Delta T \leq 40^\circ\text{C}$ . ( $T_a = 25^\circ\text{C}$ )

**Features**

- To be high saturation for surface mounting.
- Surface mounts inductor with high current rating.
- Low resistance to keep power loss minimum.
- Packed in embossed carrier tape and can be used by automatic mounting machine.

**Applications**

LCD driving circuits (DC-DC converters) such as notebook-sized personal computers, portable terminal equipment, game units.



**Shape & Dimensions**

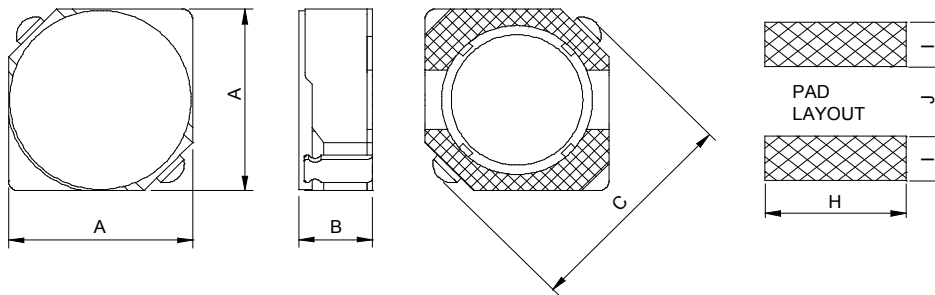

TYPE	A (mm)	B (mm)	C (mm)	H (Ref.)	I (Ref.)	J (Ref.)
AGPI3D11	4.0 MAX.	1.2±0.1	4.4 MAX.	4.6	1.65	1.0
AGPI3D16	4.0 MAX.	2.0 MAX.	5.2 MAX.	4.6	1.65	1.0
AGPI4D18	4.7±0.3	2.0 MAX.	6.9 MAX.	5.3	1.90	1.5
AGPI4D28	4.7±0.3	3.0 MAX.	6.9 MAX.	5.3	1.90	1.5
AGPI5D18	5.7±0.3	2.0 MAX.	8.2 MAX.	6.3	2.15	2.0
AGPI5D28	5.7±0.3	3.0 MAX.	8.2 MAX.	6.3	2.15	2.0
AGPI6D28	6.7±0.3	3.0 MAX.	9.5 MAX.	7.3	2.65	2.0
AGPI6D38	6.7±0.3	4.0 MAX.	9.5 MAX.	7.3	2.65	2.0

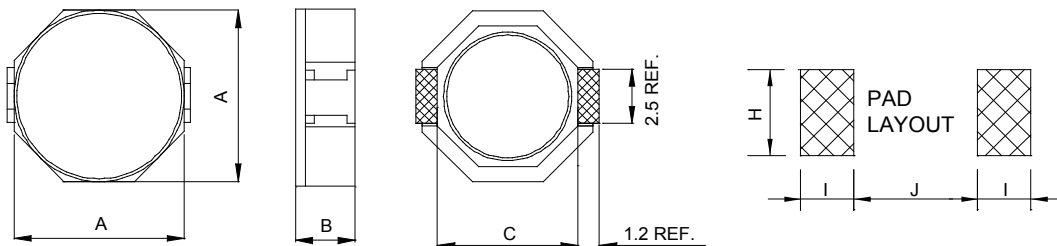

TYPE	A (mm)	B (mm)	C (mm)	H (Ref.)	I (Ref.)	J (Ref.)
AGPI8D43	8.3 MAX.	4.5 MAX.	6.3 REF.	2.8	2.00	6.1

## Shape & Dimensions

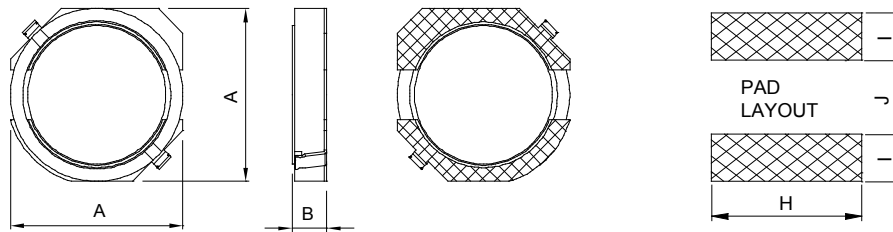

TYPE	A (mm)	B (mm)	H (Ref.)	I (Ref.)	J (Ref.)
AGPI5012	5.3 MAX.	1.2 MAX.	5.5	2.00	1.5
AGPI6012	6.0±0.3	1.2 MAX.	6.5	2.25	2.0
AGPI7D15	7.0±0.3	1.5 MAX.	7.4	2.75	1.9
AGPI7D18	7.0±0.3	1.8 MAX.	7.4	2.75	1.9
AGPI7D25	7.0±0.3	2.5 MAX.	7.4	2.75	1.9
AGPI7D28	7.0±0.3	2.8 MAX.	7.4	2.75	1.9
AGPI10D15	10.4 MAX.	1.5 MAX.	10.5	3.75	3.00
AGPI10D25	10.4 MAX.	2.5 MAX.	10.5	3.75	3.00

## Product Identification

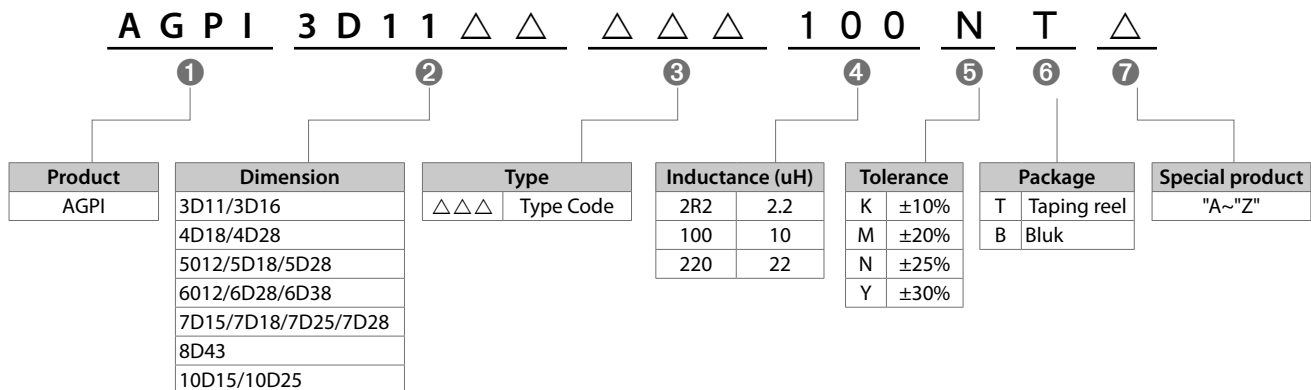

## Specification

Part Number	Inductance (H)	Test Freq. (Hz)	DCR (Ω) Max.	Saturation Current (A) Max.
<b>AGPI3D11 Series Specification</b>				
AGPI3D112R2□T	2.2u	100 K	87.3m	0.80
AGPI3D113R3□T	3.3u	100 K	118m	0.68
AGPI3D114R7□T	4.7u	100 K	123m	0.50
AGPI3D116R8□T	6.8u	100 K	180m	0.34
AGPI3D11100□T	10u	100 K	240m	0.28
AGPI3D11220□T	22u	100 K	540m	0.19
AGPI3D11330□T	33u	100 K	822m	0.15
AGPI3D11101□T	100u	100 K	3.2	0.12
AGPI3D11221□T	220u	100 K	5.5	0.08
AGPI3D11331□T	330u	100 K	9.0	0.065

### NOTE:

- The operating temperature range is -40°C to +125°C
- Isat: For Inductance drop 35% from its value without current.
- Tolerance M: ±20%, N: ±25%, Y: ±30%

### Specification

Part Number	Inductance (H)	Test Freq. (Hz)	DCR (Ω) Max.	Saturation Current (A) Max.
<b>AGPI3D16 Series Specification</b>				
AGPI3D161R5□T	1.5u	100 K	52 m	1.55
AGPI3D162R2□T	2.2u	100 K	72 m	1.20
AGPI3D163R3□T	3.3u	100 K	85 m	1.10
AGPI3D164R7□T	4.7u	100 K	105 m	0.90
AGPI3D166R8□T	6.8u	100 K	170 m	0.73
AGPI3D16100□T	10u	100 K	210 m	0.55
AGPI3D16150□T	15u	100 K	295 m	0.45
AGPI3D16220□T	22u	100 K	430 m	0.40
AGPI3D16330□T	33u	100 K	675 m	0.32
<b>AGPI4D18 Series Specification</b>				
AGPI4D181R0□T	1.0u	100 K	45 m	1.72
AGPI4D182R2□T	2.2u	100 K	75 m	1.32
AGPI4D182R7□T	2.7u	100 K	105 m	1.28
AGPI4D183R3□T	3.3u	100 K	110 m	1.04
AGPI4D183R9□T	3.9u	100 K	155 m	0.88
AGPI4D184R7□T	4.7u	100 K	162 m	0.84
AGPI4D185R6□T	5.6u	100 K	170 m	0.80
AGPI4D186R8□T	6.8u	100 K	200 m	0.76
AGPI4D188R2□T	8.2u	100 K	245 m	0.68
AGPI4D18100□T	10u	100 K	200 m	0.61
AGPI4D18120□T	12u	100 K	210 m	0.56
AGPI4D18150□T	15u	100 K	240 m	0.50
AGPI4D18180□T	18u	100 K	338 m	0.48
AGPI4D18220□T	22u	100 K	397 m	0.41
AGPI4D18270□T	27u	100 K	441 m	0.35
AGPI4D18330□T	33u	100 K	694 m	0.32
AGPI4D18390□T	39u	100 K	709 m	0.30
<b>AGPI4D28 Series Specification</b>				
AGPI4D281R2□T	1.2u	100 K	24 m	2.56
AGPI4D281R8□T	1.8u	100 K	28 m	2.20
AGPI4D282R2□T	2.2u	100 K	31 m	2.04
AGPI4D282R7□T	2.7u	100 K	43 m	1.60
AGPI4D283R3□T	3.3u	100 K	49 m	1.57
AGPI4D283R9□T	3.9u	100 K	65 m	1.44
AGPI4D284R7□T	4.7u	100 K	72 m	1.32
AGPI4D285R6□T	5.6u	100 K	101 m	1.17
AGPI4D286R8□T	6.8u	100 K	109 m	1.12
AGPI4D288R2□T	8.2u	100 K	117 m	1.04
AGPI4D28100□T	10u	100 K	128 m	1.00
AGPI4D28120□T	12u	100 K	132 m	0.84
AGPI4D28150□T	15u	100 K	149 m	0.76
AGPI4D28180□T	18u	100 K	166 m	0.72
AGPI4D28220□T	22u	100 K	235 m	0.70
AGPI4D28270□T	27u	100 K	261 m	0.58
AGPI4D28330□T	33u	100 K	331 m	0.56
AGPI4D28390□T	39u	100 K	384 m	0.50
AGPI4D28470□T	47u	100 K	587 m	0.48
AGPI4D28560□T	56u	100 K	624 m	0.41
AGPI4D28680□T	68u	100 K	699 m	0.35
AGPI4D28820□T	82u	100 K	915 m	0.32
AGPI4D28101□T	100u	100 K	1.02	0.29
AGPI4D28121□T	120u	100 K	1.27	0.27
AGPI4D28151□T	150u	100 K	1.35	0.24
AGPI4D28181□T	180u	100 K	1.54	0.22

#### NOTE:

- The operating temperature range is -40°C to +125°C
- □ Tolerance M: ±20%, N: ±25%, Y: ±30%
- Isat: For Inductance drop 35% from its value without current.



## Specification

Part Number	Inductance (H)	Test Freq. (Hz)	DCR (Ω) Max.	Saturation Current (A) Max.
<b>AGPI5D18 Series Specification</b>				
AGPI5D184R1□T	4.1u	100 K	57 m	1.95
AGPI5D185R4□T	5.4u	100 K	76 m	1.60
AGPI5D186R2□T	6.2u	100 K	96 m	1.40
AGPI5D188R9□T	8.9u	100 K	116 m	1.25
AGPI5D18100□T	10u	100 K	124 m	1.20
AGPI5D18120□T	12u	100 K	153 m	1.10
AGPI5D18150□T	15u	100 K	196 m	0.97
AGPI5D18180□T	18u	100 K	210 m	0.85
AGPI5D18220□T	22u	100 K	290 m	0.80
AGPI5D18270□T	27u	100 K	330 m	0.75
AGPI5D18330□T	33u	100 K	385 m	0.65
AGPI5D18390□T	39u	100 K	520 m	0.57
AGPI5D18470□T	47u	100 K	595 m	0.54
AGPI5D18560□T	56u	100 K	665 m	0.50
AGPI5D18680□T	68u	100 K	840 m	0.43
AGPI5D18820□T	82u	100 K	978 m	0.41
AGPI5D18101□T	100u	100 K	1.2	0.36
<b>AGPI5D28 Series Specification</b>				
AGPI5D282R5□T	2.5u	100 K	18 m	2.60
AGPI5D283R0□T	3.0u	100 K	24 m	2.40
AGPI5D284R2□T	4.2u	100 K	31 m	2.20
AGPI5D285R3□T	5.3u	100 K	38 m	1.90
AGPI5D286R2□T	6.2u	100 K	45 m	1.80
AGPI5D288R2□T	8.2u	100 K	53 m	1.60
AGPI5D28100□T	10u	100 K	65 m	1.30
AGPI5D28120□T	12u	100 K	76 m	1.20
AGPI5D28150□T	15u	100 K	103 m	1.10
AGPI5D28180□T	18u	100 K	110 m	1.00
AGPI5D28220□T	22u	100 K	122 m	0.90
AGPI5D28270□T	27u	100 K	175 m	0.85
AGPI5D28330□T	33u	100 K	189 m	0.75
AGPI5D28390□T	39u	100 K	212 m	0.70
AGPI5D28470□T	47u	100 K	250 m	0.62
AGPI5D28560□T	56u	100 K	305 m	0.58
AGPI5D28680□T	68u	100 K	355 m	0.52
AGPI5D28820□T	82u	100 K	463 m	0.46
AGPI5D28101□T	100u	100 K	520 m	0.42
<b>AGPI6D28 Series Specification</b>				
AGPI6D283R0□T	3.0u	100 K	24 m	3.00
AGPI6D283R9□T	3.9u	100 K	27 m	2.60
AGPI6D285R0□T	5.0u	100 K	31 m	2.40
AGPI6D286R0□T	6.0u	100 K	35 m	2.25
AGPI6D287R3□T	7.3u	100 K	54 m	2.10
AGPI6D288R6□T	8.6u	100 K	58 m	1.85
AGPI6D28100□T	10u	100 K	65 m	1.70
AGPI6D28120□T	12u	100 K	70 m	1.55
AGPI6D28150□T	15u	100 K	84 m	1.40
AGPI6D28180□T	18u	100 K	95 m	1.32
AGPI6D28220□T	22u	100 K	128 m	1.20
AGPI6D28270□T	27u	100 K	142 m	1.05
AGPI6D28330□T	33u	100 K	165 m	0.97
AGPI6D28390□T	39u	100 K	210 m	0.86
AGPI6D28470□T	47u	100 K	238 m	0.80
AGPI6D28560□T	56u	100 K	277 m	0.73
AGPI6D28680□T	68u	100 K	304 m	0.65
AGPI6D28820□T	82u	100 K	390 m	0.60
AGPI6D28101□T	100u	100 K	535 m	0.54

### NOTE:

- The operating temperature range is -40°C to +125°C
- Isat: For Inductance drop 35% from its value without current.
- □ Tolerance M: ±20%, N: ±25%, Y: ±30%

### Specification

Part Number	Inductance (H)	Test Freq. (Hz)	DCR ( $\Omega$ ) Max.	Saturation Current (A) Max.
<b>AGPI6D38 Series Specification</b>				
AGPI6D383R3□T	3.3u	100 K	20 m	3.50
AGPI6D385R0□T	5.0u	100 K	24 m	2.90
AGPI6D386R2□T	6.2u	100 K	27 m	2.50
AGPI6D387R4□T	7.4u	100 K	31 m	2.30
AGPI6D388R7□T	8.7u	100 K	34 m	2.20
AGPI6D38100□T	10u	100 K	38 m	2.00
AGPI6D38120□T	12u	100 K	53 m	1.70
AGPI6D38150□T	15u	100 K	57 m	1.60
AGPI6D38180□T	18u	100 K	92 m	1.50
AGPI6D38220□T	22u	100 K	96 m	1.30
AGPI6D38270□T	27u	100 K	109 m	1.20
AGPI6D38330□T	33u	100 K	124 m	1.10
AGPI6D38390□T	39u	100 K	138 m	1.00
AGPI6D38470□T	47u	100 K	155 m	0.95
AGPI6D38560□T	56u	100 K	202 m	0.85
AGPI6D38680□T	68u	100 K	234 m	0.75
AGPI6D38820□T	82u	100 K	324 m	0.70
AGPI6D38101□T	100u	100 K	358 m	0.65
<b>AGPI8D43 Series Specification</b>				
AGPI8D433R3□T	3.3u	100 K	22 m	5.80
AGPI8D434R7□T	4.7u	100 K	22 m	5.60
AGPI8D436R8□T	6.8u	100 K	38 m	4.20
AGPI8D43100□T	10u	100 K	45 m	3.70
AGPI8D43150□T	15u	100 K	53 m	2.90
AGPI8D43220□T	22u	100 K	75 m	2.10

#### NOTE:

- The operating temperature range is -40°C to +125°C
- □ Tolerance M:  $\pm 20\%$ , N:  $\pm 25\%$ , Y:  $\pm 30\%$
- Isat: For Inductance drop 35% from its value without current.

Part Number	Inductance (H)	Test Freq. (Hz)	DCR ( $\Omega$ ) Max.	Saturation Current (A) Max.	Temp. Rise current (A) Max.
<b>AGP5012 Series Specification</b>					
AGPI50123R3□T	3.3u	100 K	264m	1.60	1.25
AGPI50124R7□T	4.7u	100 K	310m	1.50	1.20
AGPI50126R8□T	6.8u	100 K	360m	1.30	1.10
AGPI50128R2□T	8.2u	100 K	480m	1.12	0.95
AGPI5012100□T	10u	100 K	530m	1.05	0.90
AGPI5012120□T	12u	100 K	600m	0.92	0.85
<b>AGPI6012 Series Specification</b>					
AGPI60123R0□T	3.0u	100 K	120 m	1.90	2.00
AGPI60124R7□T	4.7u	100 K	180 m	1.80	1.90
AGPI60126R8□T	6.8u	100 K	210 m	1.60	1.80
AGPI60128R2□T	8.2u	100 K	280 m	1.30	1.60
AGPI6012100□T	10u	100 K	310 m	1.10	1.50
AGPI6012120□T	12u	100 K	450 m	1.00	1.20
AGPI6012150□T	15u	100 K	480 m	0.95	1.10

#### NOTE:

- The operating temperature range is -40°C to +125°C
- □ Tolerance M:  $\pm 20\%$ , N:  $\pm 25\%$ , Y:  $\pm 30\%$
- Isat: For Inductance drop 35% from its value without current.
- Irms: The value of D.C current when the temperature rise is  $\Delta T \leq 40^\circ\text{C}$ . ( $T_a = 25^\circ\text{C}$ )

### Specification

Part Number	Inductance (H)	Test Freq. (Hz)	DCR ( $\Omega$ ) Max.	Saturation Current (A) Max.
<b>AGPI7D15 Series Specification</b>				
AGPI7D153R3□T	3.3u	100 K	65 m	2.80
AGPI7D154R7□T	4.7u	100 K	70 m	1.70
AGPI7D156R8□T	6.8u	100 K	106 m	2.10
AGPI7D15100□T	10u	100 K	150 m	1.40
AGPI7D15150□T	15u	100 K	195 m	1.10
AGPI7D15220□T	22u	100 K	300 m	0.90
<b>AGPI7D18 Series Specification</b>				
AGPI7D182R2□T	2.2u	100 K	60 m	3.80
AGPI7D183R3□T	3.3u	100 K	67 m	3.20
AGPI7D184R7□T	4.7u	100 K	96 m	2.80
AGPI7D185R6□T	5.6u	100 K	102 m	2.60
AGPI7D186R8□T	6.8u	100 K	142 m	2.20
AGPI7D188R0□T	8.0u	100 K	146 m	2.00
AGPI7D18100□T	10u	100 K	148 m	1.70
AGPI7D18120□T	12u	100 K	221 m	1.60
AGPI7D18150□T	15u	100 K	276 m	1.30
AGPI7D18180□T	18u	100 K	350 m	1.40
AGPI7D18220□T	22u	100 K	400 m	1.10
<b>AGPI7D25 Series Specification</b>				
AGPI7D252R7□T	2.7u	100 K	47 m	4.00
AGPI7D254R7□T	4.7u	100 K	70 m	3.20
AGPI7D256R8□T	6.8u	100 K	77 m	2.80
AGPI7D258R2□T	8.2u	100 K	92 m	2.60
AGPI7D25100□T	10u	100 K	120 m	2.40
AGPI7D25120□T	12u	100 K	130 m	2.00
AGPI7D25150□T	15u	100 K	147 m	1.70
AGPI7D25180□T	18u	100 K	193 m	1.60
AGPI7D25220□T	22u	100 K	216 m	1.50
<b>AGPI7D28 Series Specification</b>				
AGPI7D281R8□T	1.8u	100 K	27 m	4.50
AGPI7D282R7□T	2.7u	100 K	33 m	4.00
AGPI7D283R3□T	3.3u	100 K	36 m	3.50
AGPI7D284R3□T	4.3u	100 K	48 m	3.20
AGPI7D285R0□T	5.0u	100 K	49 m	3.00
AGPI7D286R2□T	6.2u	100 K	56 m	2.80
AGPI7D288R7□T	8.7u	100 K	70 m	2.60
AGPI7D28100□T	10u	100 K	77 m	2.40
AGPI7D28120□T	12u	100 K	91 m	2.20
AGPI7D28150□T	15u	100 K	104 m	1.90
AGPI7D28180□T	18u	100 K	135 m	1.80
AGPI7D28200□T	20u	100 K	150 m	1.60
AGPI7D28280□T	28u	100 K	209 m	1.40
AGPI7D28300□T	30u	100 K	223 m	1.30

#### NOTE:

- The operating temperature range is -40°C to +125°C
- Isat: For Inductance drop 35% from its value without current.
- □ Tolerance: M:  $\pm 20\%$ , N:  $\pm 25\%$ , Y:  $\pm 30\%$

### Specification

Part Number	Inductance (H)	Test Freq. (Hz)	DCR ( $\Omega$ ) Max.	Saturation Current (A) Max.	Temp. Rise current (A) Max.
<b>AGPI10D15 Series Specification</b>					
AGPI10D153R3□T	3.3u	100 K	70 m	3.40	2.90
AGPI10D154R7□T	4.7u	1M	84 m	3.6(Ref.)	2.65
AGPI10D156R8□T	6.8u	100 K	115 m	2.60	2.25
AGPI10D15100□T	10u	100 K	170 m	2.30	1.75
AGPI10D15120□T	12u	100 K	185 m	2.10	1.70
AGPI10D15150□T	15u	100 K	220 m	1.65	1.50
AGPI10D15180□T	18u	100 K	230 m	1.55	1.35
AGPI10D15220□T	22u	100 K	320 m	1.45	1.25
AGPI10D15270□T	27u	100 K	340 m	1.40	1.15
AGPI10D15330□T	33u	100 K	410 m	1.20	1.00
AGPI10D15390□T	39u	100 K	530 m	0.95	0.90
AGPI10D15470□T	47u	100 K	580 m	0.80	0.75
<b>AGPI10D25 Series Specification</b>					
AGPI10D253R3□T	3.3u	100 K	46 m	5.20	4.00
AGPI10D254R7□T	4.7u	100 K	54 m	4.20	3.70
AGPI10D256R8□T	6.8u	100 K	56 m	3.80	3.50
AGPI10D25100□T	10u	100 K	85 m	3.00	2.70
AGPI10D25120□T	12u	100 K	116 m	2.80	2.25
AGPI10D25150□T	15u	100 K	123 m	2.40	2.15
AGPI10D25180□T	18u	100 K	143 m	2.35	2.00
AGPI10D25220□T	22u	100 K	180 m	2.30	1.75
AGPI10D25270□T	27u	100 K	204 m	2.00	1.60
AGPI10D25330□T	33u	100 K	263 m	1.60	1.40
AGPI10D25390□T	39u	100 K	292 m	1.50	1.30
AGPI10D25470□T	47u	100 K	360 m	1.30	1.20
AGPI10D25560□T	56u	100 K	452 m	1.20	1.05
AGPI10D25680□T	68u	100 K	509 m	1.10	1.00

#### NOTE:

- The operating temperature range is -40°C to +105°C
- Isat: For Inductance drop 35% from its value without current.
- Irms: The value of D.C current when the temperature rise is  $\Delta T \leq 40^\circ\text{C}$ . ( $T_a = 25^\circ\text{C}$ )
- □ Tolerance M:  $\pm 20\%$ , N:  $\pm 25\%$ , Y:  $\pm 30\%$



**Features**

- To be high saturation for surface mounting.
- Surface mounts inductor with high current rating.
- Low resistance to keep power loss minimum.
- Packed in embossed carrier tape and can be used by automatic mounting machine.

**Applications**

LCD driving circuits (DC-DC converters) such as notebook-sized personal computers, portable terminal equipment, game units.

**Shape & Dimensions**

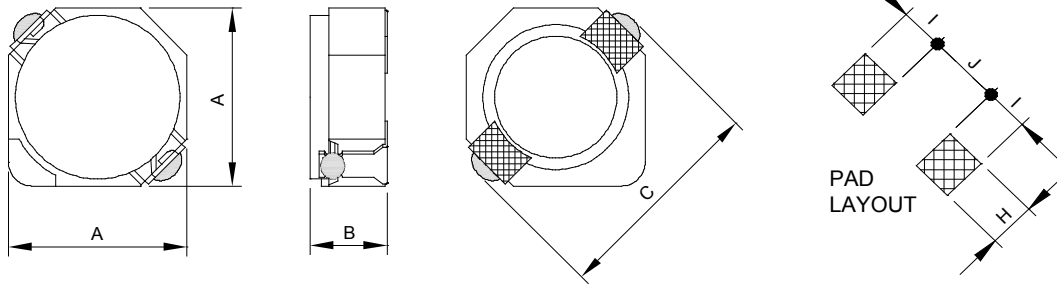

TYPE	A (mm)	B (mm)	C (mm)	H (Ref.)	I (Ref.)	J (Ref.)
AGPI2D11A	3.2 MAX.	1.2 MAX.	4.5 MAX.	1.3	1.3	1.7
AGPI3D16A	4.0 MAX.	1.8 MAX.	5.2 MAX.	1.5	1.4	2.4

**Product Identification**

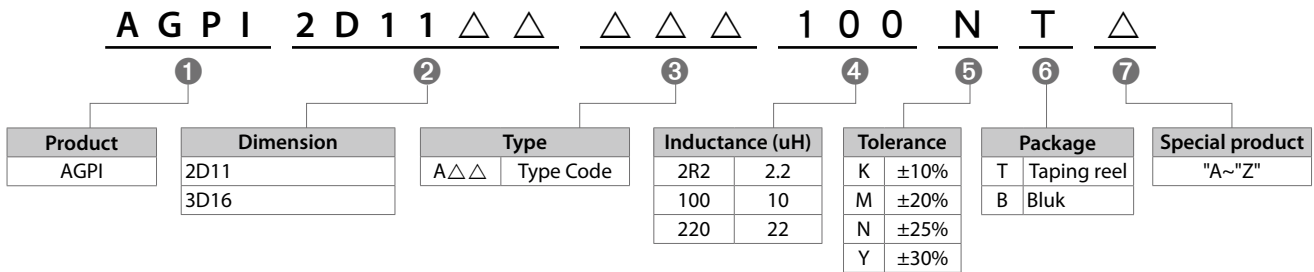

**Specification**

Part Number	Inductance (H)	Test Freq. (Hz)	DCR (mΩ) Max.	Saturation Current (A) Max.
<b>AGPI2D11A Series Specification</b>				
AGPI2D11A1R5□T	1.5u	100 K	68 m	0.90
AGPI2D11A2R2□T	2.2u	100 K	98 m	0.78
AGPI2D11A3R3□T	3.3u	100 K	123 m	0.60
AGPI2D11A4R7□T	4.7u	100 K	170 m	0.50
AGPI2D11A6R8□T	6.8u	100 K	260 m	0.44
AGPI2D11A100□T	10u	100 K	400 m	0.35
<b>AGPI3D16A Series Specification</b>				
AGPI3D16A1R5□T	1.5u	100 K	52 m	1.55
AGPI3D16A2R2□T	2.2u	100 K	72 m	1.20
AGPI3D16A3R3□T	3.3u	100 K	85 m	1.10
AGPI3D16A4R7□T	4.7u	100 K	105 m	900 m
AGPI3D16A6R8□T	6.8u	100 K	170 m	730 m
AGPI3D16A100□T	10u	100 K	210 m	550 m
AGPI3D16A150□T	15u	100 K	295 m	450 m
AGPI3D16A220□T	22u	100 K	430 m	400 m
AGPI3D16A330□T	33u	100 K	675 m	320 m

**NOTE:**

• The operating temperature range is -40°C to +125°C • □Tolerance M: ±20%, N: ±25%, Y: ±30% • Isat: For Inductance drop 30% from its value without current.

**Features**

- Low DC resistance and for large currents.
- Closed magnetic circuit crosstalk.
- Excellent solderability and heat resistance.

**Applications**

Excellent as VTR, OA equipment, LCD television sets, notebook PC, portable communication equipments, DC/DC converters, etc.



**Shape & Dimensions**

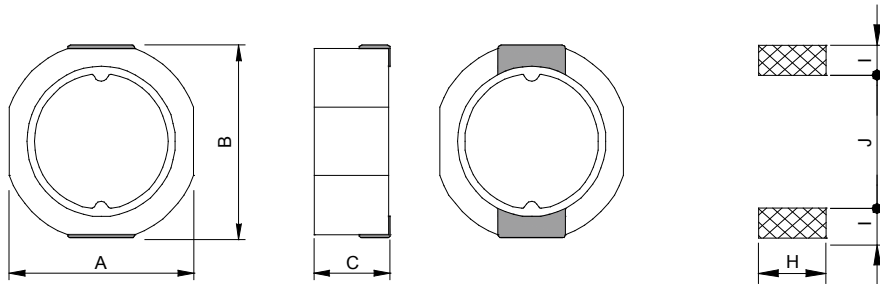

TYPE	A (mm)	B (mm)	C (mm)	H (Ref.)	I (Ref.)	J (Ref.)
ATOK7032	7.3±0.2	7.8±0.5	3.2±0.2	2.8	1.5	5.4
ATOK7045	7.3±0.2	7.8±0.5	4.5±0.3	2.8	1.5	5.4

**Product Identification**

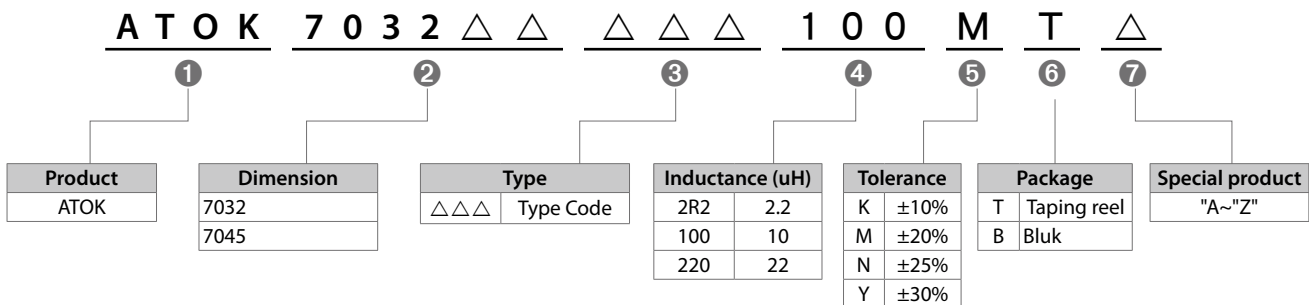

### Specification

Part Number	Inductance (H)	Test Freq. (Hz)	DCR (mΩ) Max.	Saturation Current (A) Max.	Temp. Rise current (A) Max.
<b>ATOK7032 Series Specification</b>					
ATOK70323R3□T	3.3u	100 K	28	3.70	3.50
ATOK70324R7□T	4.7u	100 K	35	3.30	3.00
ATOK70326R8□T	6.8u	100 K	49	2.40	2.20
ATOK7032100□T	10u	100 K	60	2.10	1.90
ATOK7032150□T	15u	100 K	87	1.70	1.60
ATOK7032220□T	22u	100 K	124.8	1.35	1.30
ATOK7032330□T	33u	100 K	200	1.10	1.00
ATOK7032470□T	47u	100 K	290	1.00	0.90
ATOK7032680□T	68u	100 K	370	0.80	0.80
ATOK7032101□T	100u	100 K	510	0.63	0.60
ATOK7032151□T	150u	100 K	900	0.50	0.50
ATOK7032221□T	220u	100 K	1250	0.43	0.40
ATOK7032331□T	330u	100 K	1800	0.37	0.35
ATOK7032471□T	470u	100 K	2674	0.30	0.30
ATOK7032681□T	680u	100 K	3950	0.26	0.25
ATOK7032102□T	1000u	100 K	5935	0.22	0.20
<b>ATOK7045 Series Specification</b>					
ATOK70453R3□T	3.3u	100 K	22	4.00	3.80
ATOK70454R7□T	4.7u	100 K	25	3.50	3.70
ATOK70456R8□T	6.8u	100 K	34	2.80	2.50
ATOK7045100□T	10u	100 K	39	2.60	2.50
ATOK7045150□T	15u	100 K	54	2.10	2.20
ATOK7045220□T	22u	100 K	95	1.50	1.45
ATOK7045330□T	33u	100 K	120	1.35	1.40
ATOK7045470□T	47u	100 K	213	1.10	1.00
ATOK7045680□T	68u	100 K	288	0.95	0.90
ATOK7045101□T	100u	100 K	398	0.72	0.70
ATOK7045151□T	150u	100 K	554	0.63	0.60
ATOK7045221□T	220u	100 K	838	0.50	0.48
ATOK7045331□T	330u	100 K	1360	0.40	0.36
ATOK7045471□T	470u	100 K	1876	0.35	0.32
ATOK7045681□T	680u	100 K	2772	0.28	0.27
ATOK7045102□T	1000u	100 K	4992	0.24	0.23

#### NOTE:

- The operating temperature range is -40°C to +125°C
- □ Tolerance K: ±10%, M: ±20%, N: ±25%
- Isat: For Inductance drop 35% from its value without current.
- Irms: The value of D.C current when the temperature rise is  $\Delta T \leq 40^\circ\text{C}$ . ( $T_a = 25^\circ\text{C}$ )

**Features**

- Low DC resistance and for large currents.
- Closed magnetic circuit crosstalk.
- Excellent solderability and heat resistance.

**Applications**

Excellent as VTR, OA equipment, LCD television sets, notebook PC, portable communication equipments, DC/DC converters, etc.



**Shape & Dimensions**

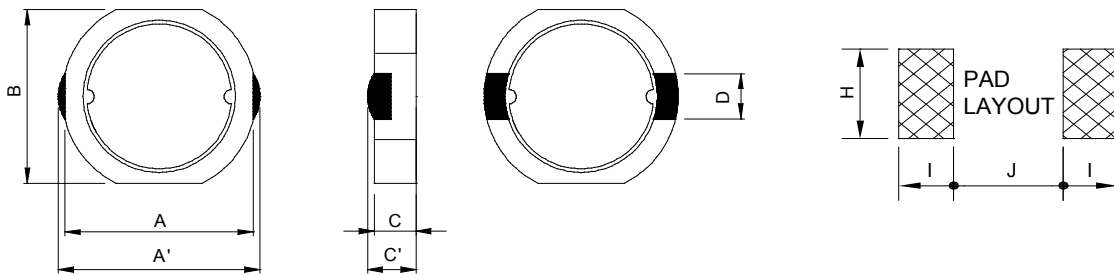

TYPE	A (mm)	A' (mm)	B (mm)	C (mm)	C' (mm)	D (mm)	H (Ref.)	I (Ref.)	J (Ref.)
ATOK7016HL	7.2±0.5	7.8±0.5	7.2±0.5	1.6 MAX.	1.6±0.2	2.5 TYP.	2.8	1.5	5.4
ATOK7020HL	7.2±0.5	7.8±0.5	7.2±0.5	2.0 MAX.	2.0±0.2	2.5 TYP.	2.8	1.5	5.4
ATOK7025HL	7.2±0.5	7.8±0.5	7.2±0.5	2.5 MAX.	2.5±0.2	2.5 TYP.	2.8	1.5	5.4

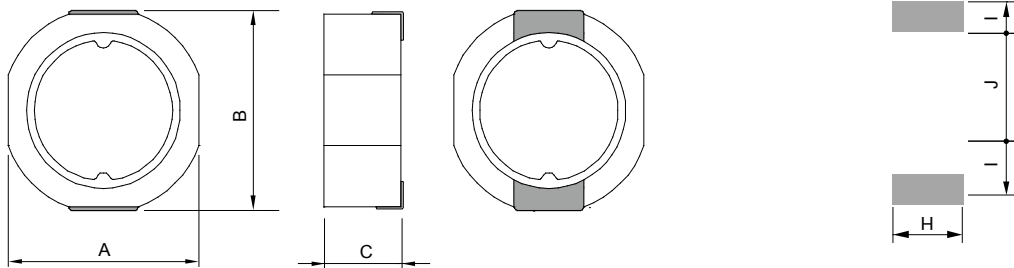

TYPE	A (mm)	B (mm)	C (mm)	H (Ref.)	I (Ref.)	J (Ref.)
ATOK7032HL	7.3±0.2	7.8±0.5	3.2±0.2	2.8	1.5	5.4
ATOK7045HL	7.3±0.2	7.8±0.5	4.5±0.3	2.8	1.5	5.4

**Product Identification**

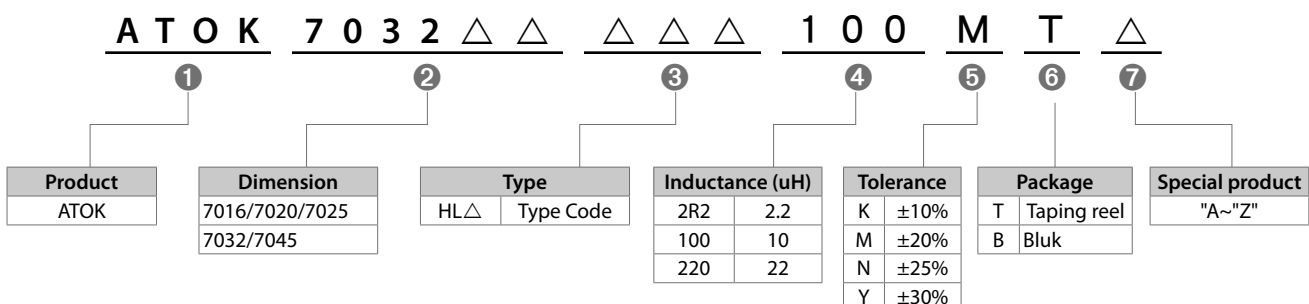

### Specification

Part Number	Inductance (H)	Test Freq. (Hz)	DCR (mΩ) Max.	Saturation Current (A) Max.	Temp. Rise current (A) Max.
<b>ATOK7016HL Series Specification</b>					
ATOK7016HL1R5□T	1.5u	1000 K	32	4.0	3.6
ATOK7016HL2R2□T	2.2u	1000 K	36	3.5	3.2
ATOK7016HL3R3□T	3.3u	1000 K	50	2.7	2.6
ATOK7016HL4R7□T	4.7u	1000 K	75	2.2	2.2
ATOK7016HL6R8□T	6.8u	1000 K	71	2.1	2.5
ATOK7016HL8R2□T	8.2u	1000 K	110	1.8	1.8
ATOK7016HL100□T	10u	1000 K	135	1.6	1.6
ATOK7016HL150□T	15u	1000 K	165	1.3	1.3
ATOK7016HL180□T	18u	1000 K	230	1.1	1.1
ATOK7016HL220□T	22u	1000 K	270	1.0	1.0
<b>ATOK7020HL Series Specification</b>					
ATOK7020HL2R2□T	2.2u	1000 K	32	4.2	3.6
ATOK7020HL3R3□T	3.3u	1000 K	45	3.7	3.3
ATOK7020HL4R7□T	4.7u	1000 K	50	3.3	3.0
ATOK7020HL6R8□T	6.8u	1000 K	74	2.8	2.5
ATOK7020HL8R2□T	8.2u	1000 K	100	2.4	2.3
ATOK7020HL100□T	10u	1000 K	115	2.2	2.2
ATOK7020HL150□T	15u	1000 K	160	1.8	1.8
ATOK7020HL180□T	18u	1000 K	195	1.6	1.6
ATOK7020HL220□T	22u	1000 K	225	1.5	1.5
<b>ATOK7025HL Series Specification</b>					
ATOK7025HL1R5□T	1.5u	1000 K	22	6.0	4.7
ATOK7025HL2R2□T	2.2u	1000 K	32	5.5	4.0
ATOK7025HL3R3□T	3.3u	1000 K	42	4.5	3.3
ATOK7025HL4R7□T	4.7u	1000 K	52	4.2	3.2
ATOK7025HL6R8□T	6.8u	1000 K	75	3.5	2.8
ATOK7025HL8R2□T	8.2u	1000 K	80	3.2	2.6
ATOK7025HL100□T	10u	1000 K	105	3.1	1.9
ATOK7025HL150□T	15u	1000 K	145	2.4	1.8
ATOK7025HL180□T	18u	1000 K	160	2.2	1.6
ATOK7025HL220□T	22u	1000 K	205	2.1	1.3

#### NOTE:

- The operating temperature range is -40°C to +125°C
- □ Tolerance M: ±20%, N: ±25%
- Isat: For Inductance drop 20% from its value without current.
- Irms: The value of D.C current when the temperature rise is  $\Delta T \leq 40^\circ\text{C}$ . (Ta=25°C)

Part Number	Inductance (H)	Test Freq. (Hz)	DCR (mΩ) Max.	Saturation Current (A) Max.	Temp. Rise current (A) Max.
<b>ATOK7032HL Series Specification</b>					
ATOK7032HL4R7□T	4.7u	100K	40	4.00	3.00
ATOK7032HL100□T	10u	100 K	60	2.90	2.20
ATOK7032HL220□T	22u	100 K	120	2.00	1.50
ATOK7032HL101□T	100u	100 K	490	0.90	0.85
ATOK7032HL181□T	180u	100 K	1000	0.55	0.55
<b>ATOK7045HL Series Specification</b>					
ATOK7045HL4R7□T	4.7u	100 K	31	4.50	3.20
ATOK7045HL100□T	10u	100 K	49	3.30	2.50
ATOK7045HL220□T	22u	100 K	86	2.10	1.80
ATOK7045HL101□T	100u	100 K	402	1.30	1.2(Typ.)
ATOK7045HL181□T	180u	100 K	582	0.80	0.70

#### NOTE:

- The operating temperature range is -40°C to +125°C
- □ Tolerance M: ±20%, N: ±25%
- Isat: For Inductance drop 30% from its value without current.
- Irms: The value of D.C current when the temperature rise is  $\Delta T \leq 40^\circ\text{C}$ . (Ta=25°C)



### Features

- To be high saturation for surface mounting.
- Surface mounts inductor with high current rating.
- Low resistance to keep power loss minimum.
- Packed in embossed carrier tape and can be used by automatic mounting machine.

### Applications

Excellent as VTR, OA equipment, LCD television sets, notebook PC, portable communication equipments, DC/DC converters, etc.



### Shape & Dimensions

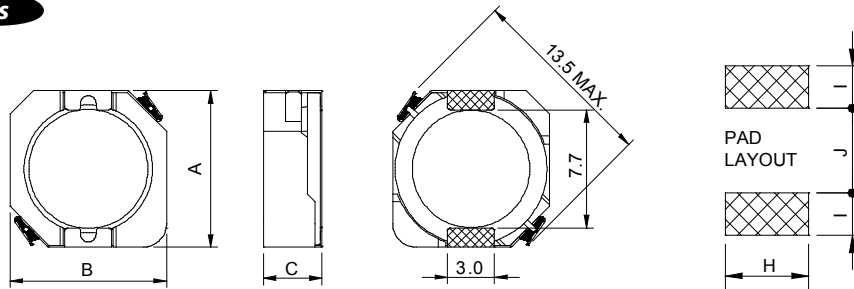

TYPE	A (mm)	B (mm)	C (mm)	H (Ref.)	I (Ref.)	J (Ref.)
AFPI1003	10.5 MAX.	10.3 MAX.	3.1 MAX.	3.6	1.7	7.3
AFPI1004	10.5 MAX.	10.3 MAX.	4.0 MAX.	3.6	1.7	7.3
AFPI1005	10.5 MAX.	10.3 MAX.	5.1 MAX.	3.6	1.7	7.3

### Product Identification

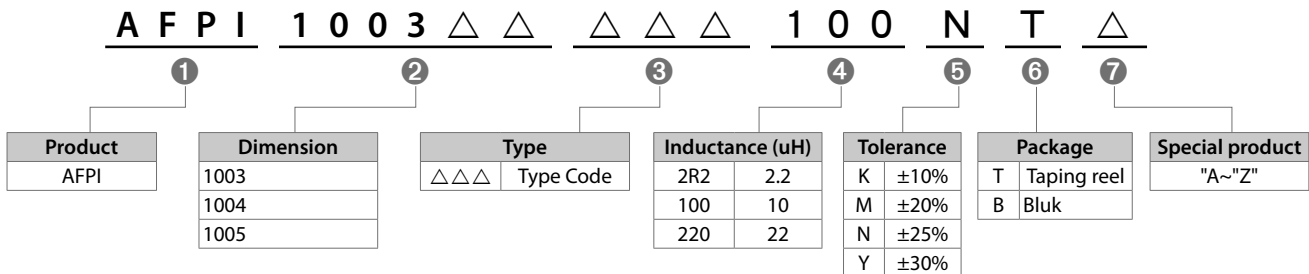

### Specification

Part Number	Inductance (H)	Test Freq. (Hz)	DCR ( $\Omega$ ) Max.	Saturation Current (A) Max.	Temp. Rise current (A) Max.
<b>AFPI1003 Series Specification</b>					
AFPI10030R8□T	0.8u	100 K	5.7 m	11.2	8.30
AFPI10031R5□T	1.5u	100 K	11.0 m	8.00	5.80
AFPI10032R2□T	2.2u	100 K	16.9 m	6.70	5.10
AFPI10033R3□T	3.3u	100 K	21.0 m	5.56	4.70
AFPI10034R7□T	4.7u	100 K	30.0 m	4.65	4.00
AFPI10036R8□T	6.8u	100 K	35.0 m	3.84	3.60
AFPI10038R2□T	8.2u	100 K	50.0 m	3.54	3.00
AFPI1003100□T	10u	100 K	59.0 m	3.18	2.80
AFPI1003150□T	15u	100 K	91.0 m	2.60	2.05
AFPI1003220□T	22u	100 K	143 m	2.16	1.60
AFPI1003330□T	33u	100 K	202 m	1.74	1.35
AFPI1003470□T	47u	100 K	299 m	1.43	1.20
AFPI1003560□T	56u	100 K	325 m	1.36	1.15
AFPI1003680□T	68u	100 K	429 m	1.22	950 m
AFPI1003820□T	82u	100 K	494 m	1.14	800 m
AFPI1003101□T	100u	100 K	683 m	1.02	700 m
AFPI1003121□T	120u	100 K	754 m	890 m	650 m
AFPI1003151□T	150u	100 K	871 m	840 m	510 m

### NOTE:

- The operating temperature range is -40°C to +105°C
- Isat: For Inductance drop 35 % from its value without current.
- □ Tolerance: M:  $\pm$ 20%, N:  $\pm$ 25%, Y:  $\pm$ 30%
- Irms: The value of D.C current when the temperature rise is  $\Delta T \leq 40^\circ\text{C}$ . ( $T_a = 25^\circ\text{C}$ )

### Specification

Part Number	Inductance (H)	Test Freq. (Hz)	DCR ( $\Omega$ ) Max.	Saturation Current (A) Max.	Temp. Rise current (A) Max.
<b>AFPI1004 Series Specification</b>					
AFPI10041R5□T	1.5u	100 K	8.1 m	10.0	6.50
AFPI10042R5□T	2.5u	100 K	10.5 m	7.50	6.10
AFPI10043R8□T	3.8u	100 K	13.0 m	6.00	5.50
AFPI10045R2□T	5.2u	100 K	22 m	5.50	5.40
AFPI10047R0□T	7.0u	100 K	34 m	4.80	4.50
AFPI1004100□T	10u	100 K	35 m	4.40	3.80
AFPI1004150□T	15u	100 K	50m	3.60	3.10
AFPI1004220□T	22u	100 K	73 m	2.90	2.50
AFPI1004330□T	33u	100 K	105 m	2.30	2.20
AFPI1004470□T	47u	100 K	128 m	2.10	1.90
AFPI1004680□T	68u	100 K	213 m	1.50	1.42
AFPI1004101□T	100u	100 K	304 m	1.35	1.25
AFPI1004151□T	150u	100 K	506 m	1.15	850 m
AFPI1004221□T	220u	100 K	756 m	0.92	700 m
AFPI1004331□T	330u	100 K	1.09	0.70	520 m
<b>AFPI1005 Series Specification</b>					
AFPI10050R8□T	0.8u	100 K	4.3 m	9.50	13.5
AFPI10051R5□T	1.5u	100 K	5.8 m	8.30	10.5
AFPI10052R2□T	2.2u	100 K	7.2 m	7.50	9.25
AFPI10053R3□T	3.3u	100 K	10.4 m	6.50	7.80
AFPI10054R7□T	4.7u	100 K	12.3 m	6.10	6.40
AFPI10056R8□T	6.8u	100 K	18 m	5.40	5.40
AFPI10058R2□T	8.2u	100 K	20 m	5.00	4.85
AFPI1005100□T	10u	100 K	26 m	4.50	4.45
AFPI1005120□T	12u	100 K	33 m	3.80	4.00
AFPI1005150□T	15u	100 K	41 m	3.40	3.60
AFPI1005180□T	18u	100 K	46 m	3.10	3.20
AFPI1005220□T	22u	100 K	61 m	2.95	2.90
AFPI1005270□T	27u	100 K	69 m	2.60	2.70
AFPI1005330□T	33u	100 K	84 m	2.50	2.40
AFPI1005390□T	39u	100 K	106 m	2.25	2.30
AFPI1005470□T	47u	100 K	130 m	2.00	2.00
AFPI1005560□T	56u	100 K	149 m	1.90	1.90
AFPI1005680□T	68u	100 K	201 m	1.60	1.65
AFPI1005820□T	82u	100 K	227 m	1.45	1.50
AFPI1005101□T	100u	100 K	253 m	1.35	1.35
AFPI1005121□T	120u	100 K	303 m	1.18	1.28
AFPI1005151□T	150u	100 K	370 m	1.10	1.12
AFPI1005181□T	180u	100 K	419 m	1.00	1.04
AFPI1005221□T	220u	100 K	500 m	940 m	940 m
AFPI1005271□T	270u	100 K	672 m	800 m	840 m
AFPI1005331□T	330u	100 K	812 m	730 m	750 m
AFPI1005391□T	390u	100 K	953 m	700 m	700 m
AFPI1005471□T	470u	100 K	1.289	540 m	600 m
AFPI1005561□T	560u	100 K	1.430	520 m	540 m
AFPI1005681□T	680u	100 K	1.599	510 m	520 m
AFPI1005821□T	820u	100 K	1.768	480 m	500 m
AFPI1005102□T	1000u	100 K	1.989	420 m	480 m

#### NOTE:

- The operating temperature range is -40°C to +105°C
- Isat: For Inductance drop 35% from its value without current.
- □ Tolerance M:  $\pm 20\%$ , N:  $\pm 25\%$ , Y:  $\pm 30\%$
- Irms: The value of D.C current when the temperature rise is  $\Delta T \leq 40^\circ\text{C}$ . ( $T_a = 25^\circ\text{C}$ )

**Features**

- Magnetic Shielded surface mount inductor with high current rating.
- Low resistance to keep power loss minimum.

**Applications**

Excellent for power line DC-DC conversion applications used in hard disk, notebook computers and other electronic equipment.



**Shape & Dimensions**

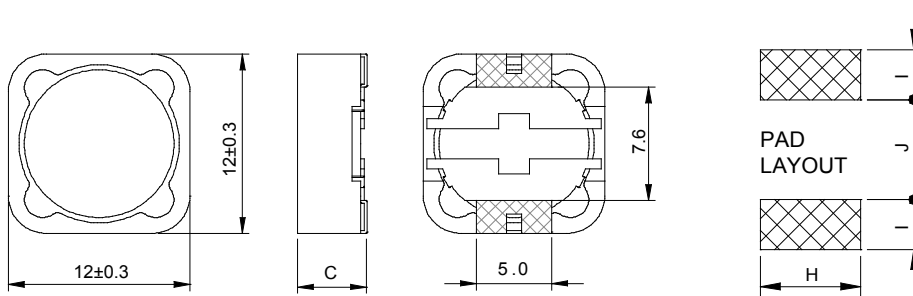

TYPE	C (mm)	H (Ref.)	I (Ref.)	J (Ref.)
ASPI1204	4.5 MAX.	5.4	2.9	7.0
ASPI1205	6.0 MAX.	5.4	2.9	7.0
ASPI1207	8.0 MAX.	5.4	2.9	7.0

**Product Identification**

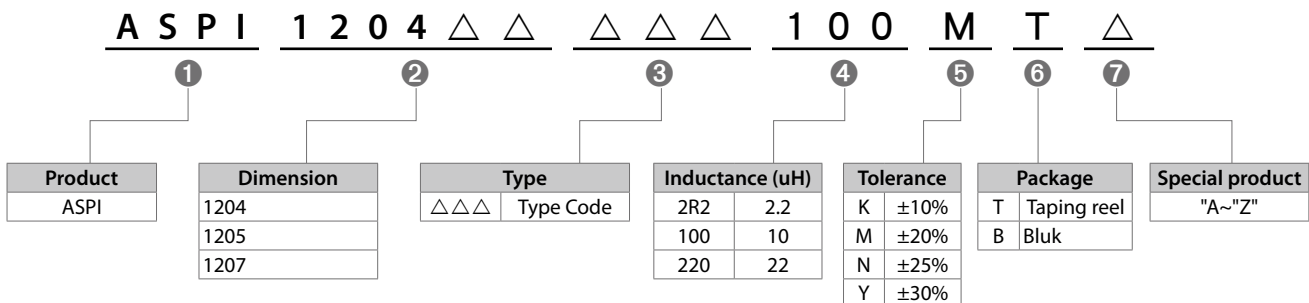

## Specification

Part Number	Inductance (H)	Test Freq. (Hz)	DCR ( $\Omega$ ) Max.	Saturation Current (A) Max.
<b>ASPI1204 Series Specification</b>				
ASPI12043R9□T	3.9u	100 K	15 m	6.50
ASPI12044R7□T	4.7u	100 K	18 m	5.70
ASPI12046R8□T	6.8u	100 K	23 m	4.90
ASPI12048R2□T	8.2u	100 K	26 m	4.60
ASPI1204100□T	10u	100 K	45 m	4.50
ASPI1204120□T	12u	100 K	38 m	4.00
ASPI1204150□T	15u	100 K	50 m	3.20
ASPI1204180□T	18u	100 K	57 m	3.10
ASPI1204220□T	22u	100 K	66 m	2.90
ASPI1204270□T	27u	100 K	80 m	2.80
ASPI1204330□T	33u	100 K	97 m	2.70
ASPI1204390□T	39u	100 K	132 m	2.10
ASPI1204470□T	47u	100 K	150 m	1.90
ASPI1204560□T	56u	100 K	190 m	1.80
ASPI1204680□T	68u	100 K	220 m	1.50
ASPI1204820□T	82u	100 K	260 m	1.30
ASPI1204101□T	100u	100 K	308 m	1.20
ASPI1204121□T	120u	100 K	0.38	1.10
ASPI1204151□T	150u	100 K	0.53	0.95
ASPI1204181□T	180u	100 K	0.62	0.85
ASPI1204221□T	220u	100 K	0.70	0.80
ASPI1204271□T	270u	100 K	0.87	0.60
ASPI1204331□T	330u	100 K	0.99	0.50
<b>ASPI1205 Series Specification</b>				
ASPI12051R3□T	1.3u	100 K	12 m	8.00
ASPI12052R1□T	2.1u	100 K	14 m	7.00
ASPI12053R1□T	3.1u	100 K	17 m	6.00
ASPI12054R4□T	4.4u	100 K	20 m	5.00
ASPI12055R8□T	5.8u	100 K	21 m	4.40
ASPI12057R5□T	7.5u	100 K	24 m	4.20
ASPI1205100□T	10u	100 K	25 m	4.00
ASPI1205120□T	12u	100 K	27 m	3.50
ASPI1205150□T	15u	100 K	30 m	3.30
ASPI1205180□T	18u	100 K	34 m	3.00
ASPI1205220□T	22u	100 K	36 m	2.80
ASPI1205270□T	27u	100 K	51 m	2.30
ASPI1205330□T	33u	100 K	57 m	2.10
ASPI1205390□T	39u	100 K	68 m	2.00
ASPI1205470□T	47u	100 K	75 m	1.80
ASPI1205560□T	56u	100 K	0.11	1.70
ASPI1205680□T	68u	100 K	0.12	1.50
ASPI1205820□T	82u	100 K	0.14	1.40
ASPI1205101□T	100u	100 K	0.16	1.30
ASPI1205121□T	120u	100 K	0.17	1.10
ASPI1205151□T	150u	100 K	0.23	1.00
ASPI1205181□T	180u	100 K	0.29	0.90
ASPI1205221□T	220u	100 K	0.40	0.80
ASPI1205271□T	270u	100 K	0.46	0.75
ASPI1205331□T	330u	100 K	0.51	0.68
ASPI1205391□T	390u	100 K	0.69	0.65
ASPI1205471□T	470u	100 K	0.77	0.58
ASPI1205561□T	560u	100 K	0.86	0.54
ASPI1205681□T	680u	100 K	1.20	0.48
ASPI1205821□T	820u	100 K	1.34	0.43
ASPI1205102□T	1000u	100 K	1.53	0.40

### NOTE:

- The operating temperature range is -40°C to +105°C
- $\square$  Tolerance M:  $\pm 20\%$ , N:  $\pm 25\%$
- Isat: For Inductance drop 25% from its value without current.

### Specification

Part Number	Inductance (H)	Test Freq. (Hz)	DCR ( $\Omega$ ) Max.	Saturation Current (A) Max.
<b>ASPI1207 Series Specification</b>				
ASPI12071R2□T	1.2u	100 K	7 m	9.80
ASPI12072R4□T	2.4u	100 K	12 m	8.00
ASPI12073R5□T	3.5u	100 K	14 m	7.50
ASPI12074R7□T	4.7u	100 K	16 m	6.80
ASPI12076R1□T	6.1u	100 K	18 m	6.60
ASPI12077R6□T	7.6u	100 K	20 m	5.90
ASPI1207100□T	10u	100 K	22 m	5.40
ASPI1207120□T	12u	100 K	25 m	4.90
ASPI1207150□T	15u	100 K	27 m	4.50
ASPI1207180□T	18u	100 K	40 m	3.90
ASPI1207220□T	22u	100 K	44 m	3.60
ASPI1207270□T	27u	100 K	46 m	3.40
ASPI1207330□T	33u	100 K	65 m	3.00
ASPI1207390□T	39u	100 K	73 m	2.75
ASPI1207470□T	47u	100 K	0.10	2.50
ASPI1207560□T	56u	100 K	0.11	2.35
ASPI1207680□T	68u	100 K	0.14	2.10
ASPI1207820□T	82u	100 K	0.16	1.95
ASPI1207101□T	100u	100 K	0.22	1.70
ASPI1207121□T	120u	100 K	0.25	1.60
ASPI1207151□T	150u	100 K	0.28	1.42
ASPI1207181□T	180u	100 K	0.35	1.30
ASPI1207221□T	220u	100 K	0.39	1.16
ASPI1207271□T	270u	100 K	0.56	1.06
ASPI1207331□T	330u	100 K	0.64	0.95
ASPI1207391□T	390u	100 K	0.70	0.88
ASPI1207471□T	470u	100 K	0.98	0.79
ASPI1207561□T	560u	100 K	1.07	0.73
ASPI1207681□T	680u	100 K	1.46	0.67
ASPI1207821□T	820u	100 K	1.64	0.60
ASPI1207102□T	1000u	100 K	1.82	0.55

#### NOTE:

- The operating temperature range is -40°C to +105°C
- □ Tolerance M:  $\pm 20\%$ , N:  $\pm 25\%$
- Isat: For Inductance drop 25% from its value without current.



**Features**

- To be high saturation for surface mounting.
- Surface mounts inductor with high current rating.
- Low resistance to keep power loss minimum.
- Packed in embossed carrier tape and can be used by automatic mounting machine.

**Applications**

Excellent as VTR, OA equipment, LCD television sets, notebook PC, portable communication equipments, DC/DC converters, etc.

**Shape & Dimensions**

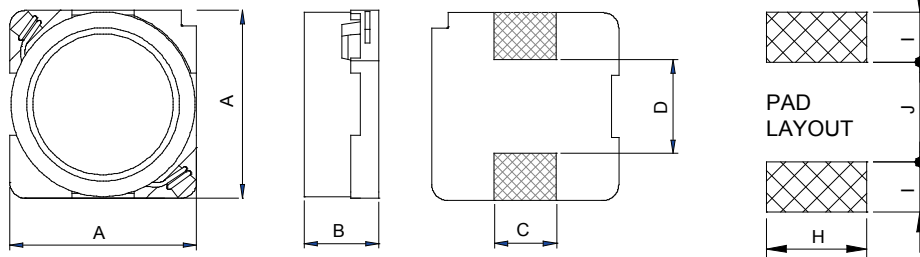

TYPE	A (mm)	B (mm)	C (mm)	D (mm)	H (Ref.)	I (Ref.)	J (Ref.)
ADPI1207HL	12.5±0.3	7.5±0.35	3.2	8.6	3.2	2.5	8.6

**Product Identification**

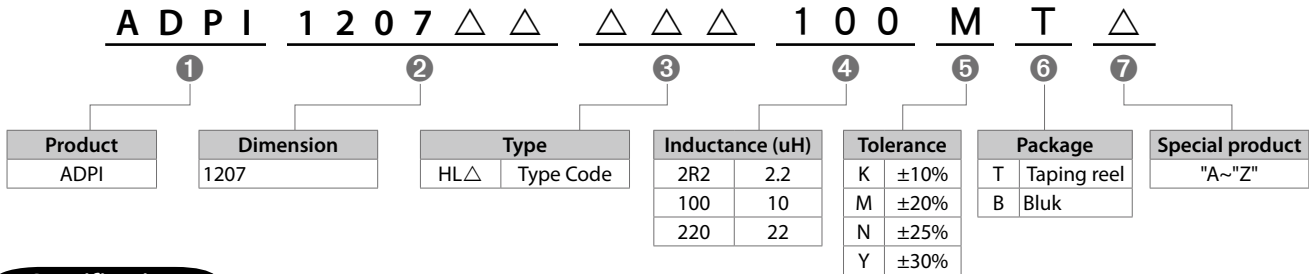

**Specification**

Part Number	Inductance (H)	Test Freq. (Hz)	DCR (mΩ) Max.	Saturation Current (A) Max.	Temp. Rise current (A) Max.
<b>ADPI1207HL Series Specification</b>					
ADPI1207HL2R7□T	2.7u	100 K	15	11.0	7.0
ADPI1207HL5R6□T	5.6u	100 K	20	8.0	6.3
ADPI1207HL6R8□T	6.8u	100 K	25	7.5	5.9
ADPI1207HL100□T	4.7u	100 K	28	6.3	5.4
ADPI1207HL120□T	12u	100 K	30	6.2	5.0
ADPI1207HL150□T	15u	100 K	31	6.0	4.3
ADPI1207HL180□T	18u	100 K	39	5.5	4.0
ADPI1207HL220□TA	22u	100 K	50	4.7	3.8
ADPI1207HL330□T	33u	100 K	62	4.5	3.2
ADPI1207HL470□T	47u	100 K	80	4.0	3.5
ADPI1207HL680□TA	68u	100 K	125	3.0	2.8
ADPI1207HL820□T	82u	100 K	120	2.7	2.5
ADPI1207HL101□T	100u	100 K	134	2.5	2.2
ADPI1207HL121□T	120u	100 K	170	2.2	2.0
ADPI1207HL151□T	150u	100 K	210	2.1	1.7
ADPI1207HL221□T	220u	100 K	320	1.5	1.3
ADPI1207HL471□T	470u	100 K	698	1.2	0.8
ADPI1207HL561□T	560u	100 K	877	1.1	0.75
ADPI1207HL821□T	820u	100 K	1164	0.9	0.63
ADPI1207HL102□T	1000u	100 K	1858	0.8	0.55

**NOTE:**

- The operating temperature range is -40°C to +105°C
- Isat: For Inductance drop 30% from its value without current.
- □ Tolerance M: ±20%, N: ±25%, Y: ±30%
- Irms: The value of D.C current when the temperature rise is ΔT≤40°C (Ta=25°C)

**Features**

The first ultra-low height realized by using new magnetic material superior in superimposed dc current characteristics with ultra-high specific resistance and by adopting a design in which a lead frame is directly bonded.

Mountable on the back side of the LCD surface because of ultra-low height type (1.0mm max.)

Low leakage flux drum core with original design applied.

Size equivalent to a half of a conventional core having the same characteristics realized, thus enabling ultralight (0.1g max.)

Automatic inserter usable in taping specifications.

All terminals are welded without lead.



**Applications**

LCD driving circuits (DC-DC converters) such as notebook-Sized personal computers, portable terminal equipment, game units.

**Shape & Dimensions**

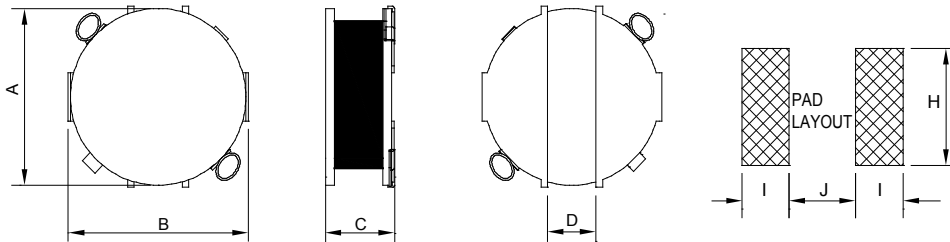

TYPE	A (mm)	B (mm)	C (mm)	D (mm)	H (mm)	I (mm)	J (mm)
AFOR0645M	6.0±0.3	6.9±0.3	4.5 MAX.	1.7 REF.	6.5	3	1.5

**Product Identification**

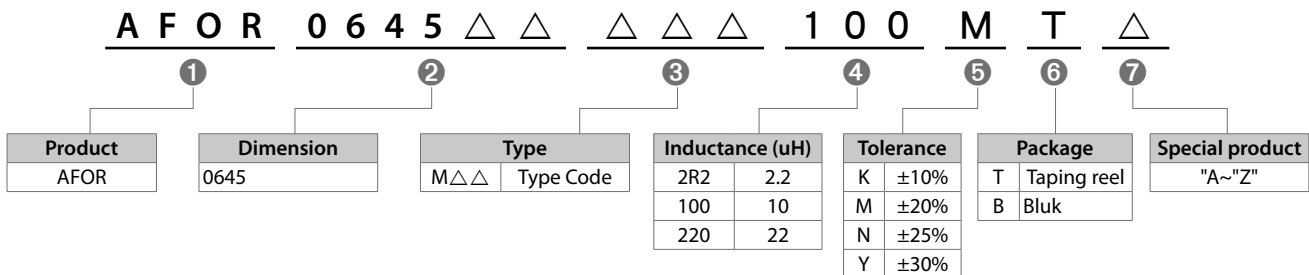

**Specification**

Part Number	Inductance (H)	Test Freq. (Hz)	DCR (mΩ) Max.	Saturation Current (A) Max.	Temp. Rise current (A) Max.
<b>AFOR0645M Series Specification</b>					
AFOR0645M1R0□T	1.0u	100 K	17.0	8.60	6.50
AFOR0645M1R5□T	1.5u	100 K	24.0	7.20	5.40
AFOR0645M2R2□T	2.2u	100 K	26.0	6.40	5.10
AFOR0645M3R3□T	3.3u	100 K	33.0	5.20	4.60
AFOR0645M4R7□T	4.7u	100 K	38.0	4.40	4.10
AFOR0645M6R8□T	6.8u	100 K	57.0	3.80	3.30
AFOR0645M100□T	10u	100 K	72.0	3.20	3.00
AFOR0645M150□T	15u	100 K	112.0	2.50	2.30
AFOR0645M220□T	22u	100 K	140.0	2.10	2.00
AFOR0645M330□T	33u	100 K	202.0	1.60	1.50
AFOR0645M470□T	47u	100 K	299.0	1.40	1.40
AFOR0645M680□T	68u	100 K	455.0	1.10	1.00
AFOR0645M101□T	100u	100 K	663.0	0.90	0.80

**NOTE:**

- The operating temperature range is -40°C to +85°C
- Isat: For Inductance drop 30% from its value without current.
- □ Tolerance: M: ±20%, N: ±25%, Y: ±30%
- Irms: The value of D.C current when the temperature rise is  $\Delta T \leq 40^\circ\text{C}$ . (Ta=25°C)

**Features**

- Low profile very effective in space-conscious applications.
- Low resistance and high energy storage.

**Applications**

Excellent as DC-DC Converter used in notebooks computers, PDA and mobile headphones. Step-up or step-down converters, flash memory.



**Shape & Dimensions**

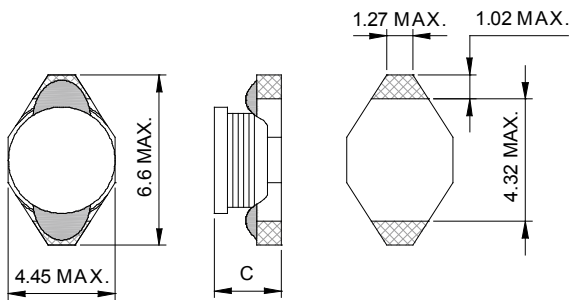

Fig.1

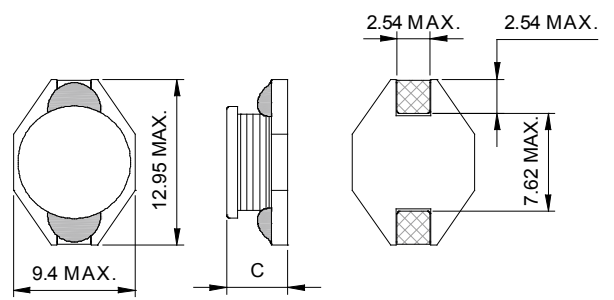

Fig.2

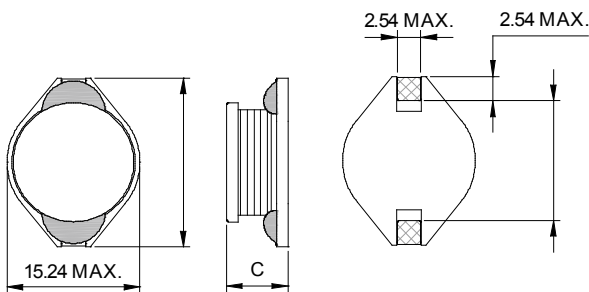
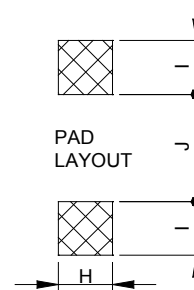
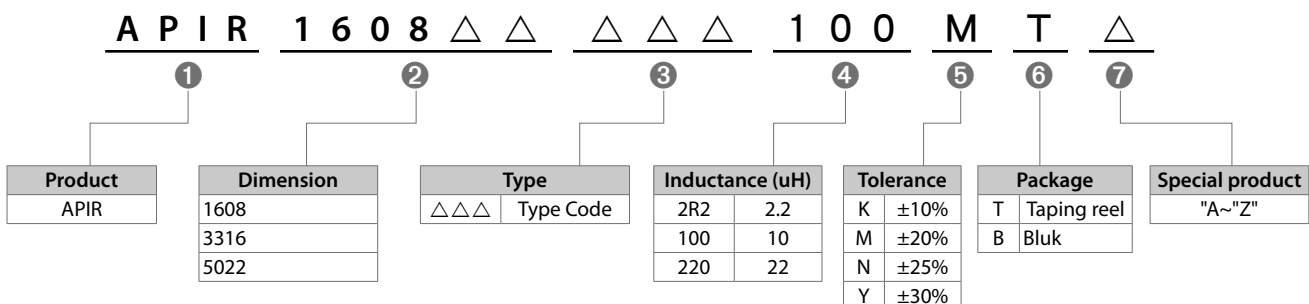

Fig.3



TYPE	Figure	C (mm)	H (Ref.)	I (Ref.)	J (Ref.)
APIR1608	1	2.92 MAX.	3.56	1.40	4.06
APIR3316	2	5.08 MAX.	2.79	2.92	7.37
APIR5022	3	7.62 MAX.	2.79	2.92	12.45

**Product Identification**



### Specification

Part Number	Inductance (H)	Test Freq. (Hz)	DCR (Ω) Max.	Temp. Rise current (A) Typ.
<b>APIR1608 Series Specification</b>				
APIR16081R0□T	1.0u	100 K	40 m	3.00
APIR16081R5□T	1.5u	100 K	45 m	2.80
APIR16082R2□T	2.2u	100 K	50 m	1.80
APIR16083R3□T	3.3u	100 K	55 m	1.60
APIR16084R7□T	4.7u	100 K	60 m	1.40
APIR16086R8□T	6.8u	100 K	65 m	1.20
APIR1608100□T	10u	100 K	75 m	1.00
APIR1608150□T	15u	100 K	90 m	0.80
APIR1608220□T	22u	100 K	110 m	0.70
APIR1608330□T	33u	100 K	190 m	0.60
APIR1608470□T	47u	100 K	230 m	0.50
APIR1608680□T	68u	100 K	290 m	0.40
APIR1608101□T	100u	100 K	480 m	0.30
APIR1608151□T	150u	100 K	590 m	0.26
APIR1608221□T	220u	100 K	770 m	0.22
APIR1608331□T	330u	100 K	1.4	0.20
APIR1608471□T	470u	100 K	1.8	0.19
APIR1608681□T	680u	100 K	2.2	0.18
APIR1608102□T	1.0 m	100 K	3.4	0.15
APIR1608152□T	1.5 m	100 K	4.2	0.12
APIR1608222□T	2.2 m	100 K	8.5	0.10
APIR1608332□T	3.3 m	100 K	11.0	0.08
APIR1608472□T	4.7 m	100 K	13.9	0.06
APIR1608682□T	6.8 m	100 K	25.0	0.04
APIR1608103□T	10 m	100 K	32.8	0.02

#### NOTE:

- The operating temperature range is -40°C to +125°C • □ Tolerance K: ±10%, M: ±20%
- Irms: The actual current when temperature of coil becomes  $\Delta T=40^{\circ}\text{C}$

Part Number	Inductance (H)	Test Freq. (Hz)	DCR (Ω) Max.	Saturation Current (A) Max.
<b>APIR3316 Series Specification</b>				
APIR33161R0□T	1.0u	100 K	21 m	5.6
APIR33161R5□T	1.5u	100 K	22 m	5.2
APIR33162R2□T	2.2u	100 K	32 m	5.0
APIR33163R3□T	3.3u	100 K	39 m	3.9
APIR33164R7□T	4.7u	100 K	54 m	3.2
APIR33166R8□T	6.8u	100 K	75 m	2.8
APIR3316100□T	10u	100 K	101 m	2.4
APIR3316150□T	15u	100 K	150 m	2.0
APIR3316220□T	22u	100 K	207 m	1.6
APIR3316330□T	33u	100 K	334 m	1.4
APIR3316470□T	47u	100 K	472 m	1.0
<b>APIR5022 Series Specification</b>				
APIR5022100□T	10u	100 K	40 m	8.00
APIR5022150□T	15u	100 K	48 m	7.00
APIR5022220□T	22u	100 K	59 m	6.00
APIR5022330□T	33u	100 K	75 m	5.00
APIR5022470□T	47u	100 K	97 m	4.00
APIR5022680□T	68u	100 K	138 m	3.00
APIR5022101□T	100u	100 K	207 m	2.40
APIR5022151□T	150u	100 K	293 m	2.10
APIR5022221□T	220u	100 K	470 m	1.90
APIR5022331□T	330u	100 K	780 m	1.10
APIR5022471□T	470u	100 K	1.08	1.10
APIR5022681□T	680u	100 K	1.40	0.96
APIR5022102□T	1.0 m	100 K	2.01	0.80

#### NOTE:

- The operating temperature range is -40°C to +125°C • □ Tolerance K: ±10%, M: ±20%
- Isat: For Inductance drop 15% from its value without current.

**Features**

- Low profile very effective in space-conscious applications.
- Low resistance and high energy storage.

**Applications**

Excellent as DC-DC Converter used in notebooks computers, PDA and mobile headphones. Step-up or step-down converters, flash memory.



**Shape & Dimensions**

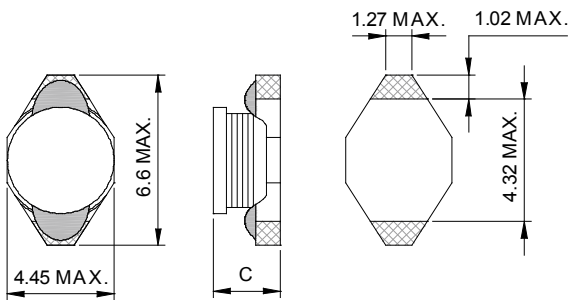

Fig.1

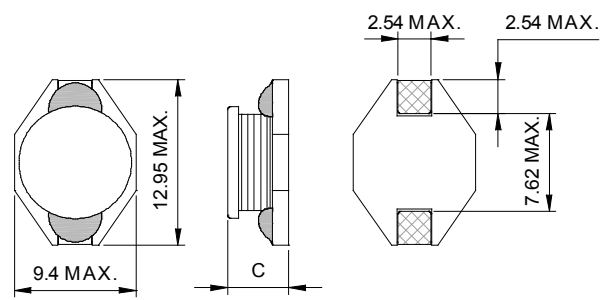

Fig.2

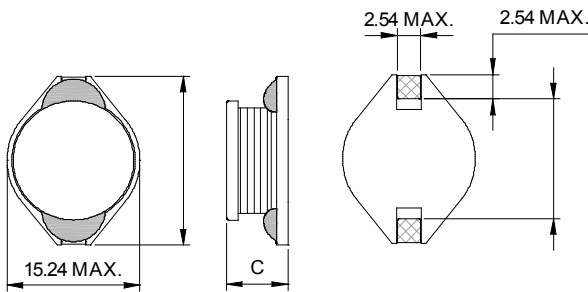
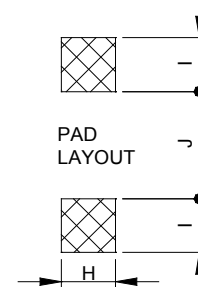
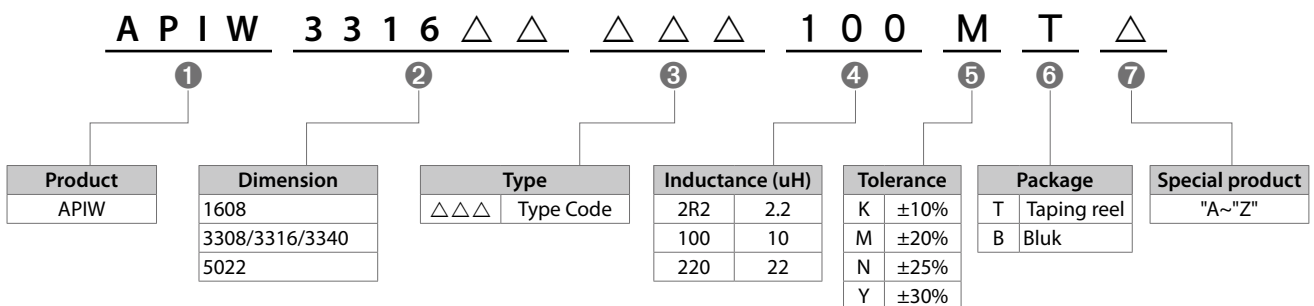

Fig.3



TYPE	Figure	C (mm)	H (Ref.)	I (Ref.)	J (Ref.)
APIW1608	1	2.92 MAX.	3.56	1.40	4.06
APIW3308	2	3.00 MAX.	2.79	2.92	7.37
APIW3316	2	5.21 MAX.	2.79	2.92	7.37
APIW3340	2	11.43 MAX.	2.79	2.92	7.37
APIW5022	3	7.11 MAX.	2.79	2.92	12.45

**Product Identification**





### Specification

Part Number	Inductance (H)	Test Freq. (Hz)	DCR (Ω) Max.	Saturation Current (A) Max.
<b>APIW1608 Series Specification</b>				
APIW16081R0□T	1.0u	100 K	50 m	2.90
APIW16081R5□T	1.5u	100 K	50 m	2.60
APIW16082R2□T	2.2u	100 K	70 m	2.30
APIW16083R3□T	3.3u	100 K	80 m	2.00
APIW16084R7□T	4.7u	100 K	90 m	1.50
APIW16086R8□T	6.8u	100 K	130 m	1.20
APIW1608100□T	10u	100 K	160 m	1.10
APIW1608150□T	15u	100 K	230 m	0.90
APIW1608220□T	22u	100 K	370 m	0.70
APIW1608330□T	33u	100 K	510 m	0.58
APIW1608470□T	47u	100 K	640 m	0.50
APIW1608680□T	68u	100 K	860 m	0.40
APIW1608101□T	100u	100 K	1.27	0.31
APIW1608151□T	150u	100 K	2.00	0.27
APIW1608221□T	220u	100 K	2.65	0.22
APIW1608331□T	330u	100 K	3.80	0.18
APIW1608471□T	470u	100 K	5.06	0.16
APIW1608681□T	680u	100 K	9.20	0.14
APIW1608102□T	1000u	100 K	13.8	0.10
<b>APIW3308 Series Specification</b>				
APIW3308100□T	10u	100 K	85 m	2.4
APIW3308150□T	15u	100 K	120 m	2.0
APIW3308220□T	22u	100 K	180 m	1.6
APIW3308330□T	33u	100 K	250 m	1.4
APIW3308470□T	47u	100 K	320 m	1.0
APIW3308680□T	68u	100 K	540 m	0.9
APIW3308101□T	100u	100 K	690 m	0.7
APIW3308151□T	150u	100 K	940 m	0.6
APIW3308221□T	220u	100 K	1.60	0.5
APIW3308331□T	330u	100 K	2.15	0.4
APIW3308471□T	470u	100 K	3.30	0.3
APIW3308681□T	680u	100 K	4.40	0.2
APIW3308102□T	1000u	100 K	7.00	0.1
<b>APIW3316 Series Specification</b>				
APIW33161R0□T	1.0u	100 K	9 m	9.0
APIW33161R5□T	1.5u	100 K	10 m	8.0
APIW33162R2□T	2.2u	100 K	12 m	7.0
APIW33163R3□T	3.3u	100 K	15 m	6.4
APIW33164R7□T	4.7u	100 K	18 m	5.4
APIW33166R8□T	6.8u	100 K	27 m	4.6
APIW3316100□T	10u	100 K	38 m	3.8
APIW3316150□T	15u	100 K	46 m	3.0
APIW3316220□T	22u	100 K	85 m	2.6
APIW3316330□T	33u	100 K	0.10	2.0
APIW3316470□T	47u	100 K	0.14	1.6
APIW3316680□T	68u	100 K	0.20	1.4
APIW3316101□T	100u	100 K	0.28	1.2
APIW3316151□T	150u	100 K	0.40	1.0
APIW3316221□T	220u	100 K	0.61	0.8
APIW3316331□T	330u	100 K	1.02	0.6
APIW3316471□T	470u	100 K	1.27	0.5
APIW3316681□T	680u	100 K	2.02	0.4
APIW3316102□T	1000u	100 K	3.00	0.3

#### NOTE:

- The operating temperature range is -40°C to +125°C
- Isat: For Inductance drop 15% from its value without current.
- □ Tolerance K: ±10%, M: ±20%

### Specification

Part Number	Inductance (H)	Test Freq. (Hz)	DCR ( $\Omega$ ) Max.	Saturation Current (A) Max.
<b>APIW3340 Series Specification</b>				
APIW3340100□T	10u	100 K	0.04	8.0
APIW3340150□T	15u	100 K	0.05	7.0
APIW3340220□T	22u	100 K	0.066	5.5
APIW3340330□T	33u	100 K	0.08	4.0
APIW3340470□T	47u	100 K	0.11	3.8
APIW3340680□T	68u	100 K	0.17	3.0
APIW3340101□T	100u	100 K	0.22	2.5
APIW3340151□T	150u	100 K	0.34	2.0
APIW3340221□T	220u	100 K	0.44	1.6
APIW3340331□T	330u	100 K	0.70	1.2
APIW3340471□T	470u	100 K	0.95	1.0
APIW3340681□T	680u	100 K	1.40	1.0
APIW3340102□T	1000u	100 K	2.00	0.8
<b>APIW5022 Series Specification</b>				
APIW50221R0□T	1.0u	100 K	9 m	20.0
APIW50222R2□T	2.2u	100 K	14 m	16.0
APIW50223R3□T	3.3u	100 K	15 m	14.0
APIW50225R6□T	5.6u	100 K	20 m	12.0
APIW5022100□T	10u	100 K	31 m	10.0
APIW5022150□T	15u	100 K	36 m	8.0
APIW5022220□T	22u	100 K	47 m	7.0
APIW5022330□T	33u	100 K	66 m	5.5
APIW5022470□T	47u	100 K	86 m	4.5
APIW5022680□T	68u	100 K	130 m	3.5
APIW5022101□T	100u	100 K	190 m	3.0
APIW5022151□T	150u	100 K	250 m	2.6
APIW5022221□T	220u	100 K	380 m	2.4
APIW5022331□T	330u	100 K	560 m	1.9
APIW5022471□T	470u	100 K	850 m	1.4
APIW5022681□T	680u	100 K	1.40	1.2
APIW5022102□T	1000u	100 K	1.80	1.0

#### NOTE:

- The operating temperature range is -40°C to +125°C
- Isat: For Inductance drop 15% from its value without current.
- □ Tolerance K:  $\pm 10\%$ , M:  $\pm 20\%$

**Features**

- Excellent solderability and high heat resistance
- Excellent terminal strength construction.
- Packed in embossed carrier tape and can be used by automatic mounting machine.

**Applications**

Power supply for VCR, OA equipment, LCD television set, notebook, DC to DC converters, DC to AC inverters etc.



**Shape & Dimensions**

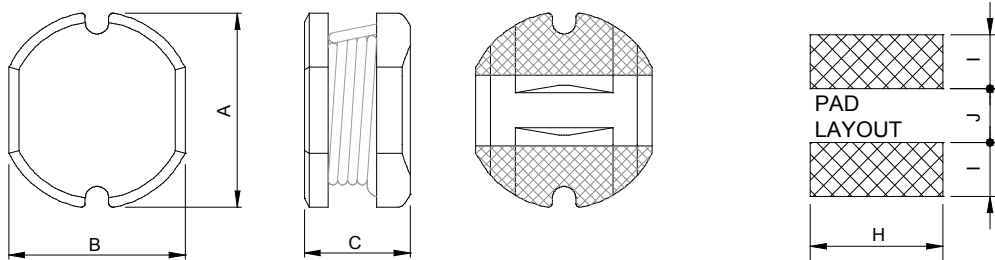

TYPE	A (mm)	B (mm)	C (mm)	H (Ref.)	I (Ref.)	J (Ref.)
ATPI0301	3.5±0.3	3.0±0.3	1.3 MAX.	3.5	1.5	1.0
ATPI0302	3.5±0.3	3.0±0.3	2.1±0.3	3.5	1.5	1.0
ATPI0403	4.5±0.3	4.0±0.3	3.2±0.3	4.5	1.8	1.5
ATPI0504	5.8±0.3	5.2±0.3	4.5±0.4	5.5	2.2	1.7
ATPI0703	7.8±0.3	7.0±0.3	3.5±0.5	7.5	3.0	2.0
ATPI0705	7.8±0.3	7.0±0.3	5.0±0.5	7.5	3.0	2.0
ATPI1005	10.0±0.4	9.0±0.4	5.4±0.4	9.5	3.8	2.5

**Product Identification**

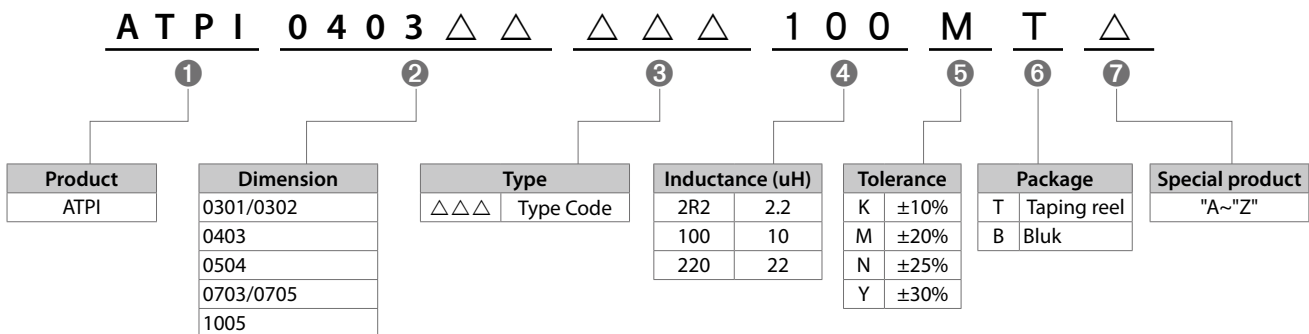

### Specification

Part Number	Inductance (H)	Test Freq. (Hz)	DCR (Ω) Max.	Saturation Current (A) Max.
<b>ATPI0301 Series Specification</b>				
ATPI03011R5□T	1.5u	100 K	0.15	1.60
ATPI03013R3□T	3.3u	100 K	0.25	1.20
ATPI03014R7□T	4.7u	100 K	0.28	1.00
ATPI03016R8□T	6.8u	100 K	0.54	0.80
ATPI03018R2□T	8.2u	100 K	0.56	0.70
ATPI0301100□T	10u	100 K	0.60	0.60
ATPI0301120□T	12u	100 K	0.80	0.50
ATPI0301150□T	15u	100 K	1.05	0.45
ATPI0301220□T	22u	100 K	1.20	0.37

**NOTE:**

• The operating temperature range is -40°C to +125°C • □ Tolerance K: ±10%, M: ±20% • Isat: For Inductance drop 20% from its value without current.

Part Number	Inductance (H)	Test Freq. (Hz)	DCR (Ω) Max.	Saturation Current (A) Max.
<b>ATPI0302 Series Specification</b>				
ATPI03021R5□T	1.5u	100 K	0.06	2.00
ATPI03022R2□T	2.2u	100 K	0.09	1.60
ATPI03023R3□T	3.3u	100 K	0.10	1.50
ATPI03024R7□T	4.7u	100 K	0.20	1.40
ATPI03026R8□T	6.8u	100 K	0.30	1.00
ATPI03028R2□T	8.2u	100 K	0.32	1.00
ATPI0302100□T	10u	100 K	0.35	1.00
ATPI0302120□T	12u	100 K	0.40	0.90
ATPI0302150□T	15u	100 K	0.60	0.60
ATPI0302180□T	18u	100 K	0.70	0.60
ATPI0302220□T	22u	100 K	1.00	0.50
ATPI0302270□T	27u	100 K	1.10	0.45
ATPI0302330□T	33u	100 K	1.30	0.40
ATPI0302390□T	39u	100 K	1.50	0.35
ATPI0302470□T	47u	100 K	2.00	0.35
ATPI0302680□T	68u	100 K	2.20	0.30
ATPI0302820□T	82u	100 K	2.80	0.25
ATPI0302101□T	100u	100 K	3.20	0.20
ATPI0302121□T	120u	100 K	4.00	0.18
ATPI0302151□T	150u	100 K	4.30	0.15
ATPI0302301□T	300u	100 K	7.00	0.10
ATPI0302331□T	330u	100 K	7.00	0.10
<b>ATPI0403 Series Specification</b>				
ATPI04031R0□T	1.0u	100 K	49 m	2.56
ATPI04031R4□T	1.4u	100 K	57 m	2.52
ATPI04031R8□T	1.8u	100 K	64 m	1.95
ATPI04032R2□T	2.2u	100 K	72 m	1.75
ATPI04032R7□T	2.7u	100 K	79 m	1.58
ATPI04033R3□T	3.3u	100 K	87 m	1.44
ATPI04033R9□T	3.9u	100 K	94 m	1.33
ATPI04034R7□T	4.7u	100 K	109 m	1.15
ATPI04035R6□T	5.6u	100 K	126 m	0.99
ATPI04036R8□T	6.8u	100 K	132 m	0.95
ATPI04038R2□T	8.2u	100 K	147 m	0.84
ATPI0403100□T	10u	100 K	182 m	1.04
ATPI0403120□T	12u	100 K	210 m	0.97
ATPI0403150□T	15u	100 K	235 m	0.85
ATPI0403180□T	18u	100 K	338 m	0.74
ATPI0403220□T	22u	100 K	378 m	0.68
ATPI0403270□T	27u	100 K	522 m	0.62
ATPI0403330□T	33u	100 K	540 m	0.56
ATPI0403390□T	39u	100 K	587 m	0.52
ATPI0403470□T	47u	100 K	844 m	0.44
ATPI0403560□T	56u	100 K	937 m	0.42
ATPI0403680□T	68u	100 K	1117 m	0.37

**NOTE:**

• The operating temperature range is -40°C to +125°C • □ Tolerance K: ±10%, M: ±20% • Isat: For Inductance drop 10% from its value without current.

### Specification

Part Number	Inductance (H)	Test Freq. (Hz)	DCR ( $\Omega$ ) Max.	Saturation Current (A) Max.
<b>ATPI0504 Series Specification</b>				
ATPI0504100□T	10u	100 K	0.10	1.44
ATPI0504120□T	12u	100 K	0.12	1.40
ATPI0504150□T	15u	100 K	0.14	1.30
ATPI0504180□T	18u	100 K	0.15	1.23
ATPI0504220□T	22u	100 K	0.18	1.11
ATPI0504270□T	27u	100 K	0.20	0.97
ATPI0504330□T	33u	100 K	0.23	0.88
ATPI0504390□T	39u	100 K	0.32	0.80
ATPI0504470□T	47u	100 K	0.37	0.72
ATPI0504560□T	56u	100 K	0.42	0.68
ATPI0504680□T	68u	100 K	0.46	0.61
ATPI0504820□T	82u	100 K	0.60	0.58
ATPI0504101□T	100u	100 K	0.70	0.52
ATPI0504121□T	120u	100 K	0.93	0.48
ATPI0504151□T	150u	100 K	1.10	0.40
ATPI0504181□T	180u	100 K	1.38	0.38
ATPI0504221□T	220u	100 K	1.57	0.35
<b>ATPI0703 Series Specification</b>				
ATPI0703100□T	10u	100 K	0.081	1.44
ATPI0703120□T	12u	100 K	0.090	1.39
ATPI0703150□T	15u	100 K	0.104	1.24
ATPI0703180□T	18u	100 K	0.111	1.12
ATPI0703220□T	22u	100 K	0.129	1.07
ATPI0703270□T	27u	100 K	0.153	0.94
ATPI0703330□T	33u	100 K	0.170	0.85
ATPI0703390□T	39u	100 K	0.217	0.74
ATPI0703470□T	47u	100 K	0.252	0.68
ATPI0703560□T	56u	100 K	0.282	0.64
ATPI0703680□T	68u	100 K	0.332	0.59
ATPI0703820□T	82u	100 K	0.406	0.54
ATPI0703101□T	100u	100 K	0.481	0.51
ATPI0703121□T	120u	100 K	0.536	0.49
ATPI0703151□T	150u	100 K	0.755	0.40
ATPI0703181□T	180u	100 K	1.022	0.36
ATPI0703221□T	220u	100 K	1.200	0.31
ATPI0703271□T	270u	100 K	1.306	0.29
ATPI0703331□T	330u	100 K	1.495	0.28
<b>ATPI0705 Series Specification</b>				
ATPI0705100□T	10u	100 K	0.07	2.30
ATPI0705120□T	12u	100 K	0.08	2.00
ATPI0705150□T	15u	100 K	0.09	1.80
ATPI0705180□T	18u	100 K	0.10	1.60
ATPI0705220□T	22u	100 K	0.11	1.50
ATPI0705270□T	27u	100 K	0.12	1.30
ATPI0705330□T	33u	100 K	0.13	1.20
ATPI0705390□T	39u	100 K	0.16	1.10
ATPI0705470□T	47u	100 K	0.18	1.10
ATPI0705560□T	56u	100 K	0.24	0.94
ATPI0705680□T	68u	100 K	0.28	0.85
ATPI0705820□T	82u	100 K	0.37	0.78
ATPI0705101□T	100u	100 K	0.43	0.72
ATPI0705121□T	120u	100 K	0.47	0.66
ATPI0705151□T	150u	100 K	0.64	0.58

#### NOTE:

- The operating temperature range is -40°C to +125°C • □ Tolerance K:  $\pm 10\%$ , M:  $\pm 20\%$
- Isat: For Inductance drop 10% from its value without current.



### Specification

Part Number	Inductance (H)	Test Freq. (Hz)	DCR ( $\Omega$ ) Max.	Saturation Current (A) Max.
<b>ATPI0705 Series Specification</b>				
ATPI0705181□T	180u	100 K	0.71	0.51
ATPI0705221□T	220u	100 K	0.96	0.49
ATPI0705271□T	270u	100 K	1.11	0.42
ATPI0705331□T	330u	100 K	1.26	0.40
ATPI0705391□T	390u	100 K	1.77	0.36
ATPI0705471□T	470u	100 K	1.96	0.34
<b>ATPI1005 Series Specification</b>				
ATPI1005100□T	10u	100 K	0.06	2.60
ATPI1005120□T	12u	100 K	0.07	2.45
ATPI1005150□T	15u	100 K	0.08	2.27
ATPI1005180□T	18u	100 K	0.09	2.15
ATPI1005220□T	22u	100 K	0.10	1.95
ATPI1005270□T	27u	100 K	0.11	1.76
ATPI1005330□T	33u	100 K	0.12	1.50
ATPI1005390□T	39u	100 K	0.14	1.37
ATPI1005470□T	47u	100 K	0.17	1.28
ATPI1005560□T	56u	100 K	0.19	1.17
ATPI1005680□T	68u	100 K	0.22	1.11
ATPI1005820□T	82u	100 K	0.25	1.00
ATPI1005101□T	100u	100 K	0.35	0.97
ATPI1005121□T	120u	100 K	0.40	0.89
ATPI1005151□T	150u	100 K	0.47	0.78
ATPI1005181□T	180u	100 K	0.63	0.72
ATPI1005221□T	220u	100 K	0.73	0.66
ATPI1005271□T	270u	100 K	0.97	0.57
ATPI1005331□T	330u	100 K	1.15	0.52
ATPI1005391□T	390u	100 K	1.30	0.48
ATPI1005471□T	470u	100 K	1.48	0.42
ATPI1005561□T	560u	100 K	1.90	0.33
ATPI1005681□T	680u	100 K	2.25	0.28
ATPI1005821□T	820u	100 K	2.55	0.24

#### NOTE:

- The operating temperature range is -40°C to +125°C    • □ Tolerance K:  $\pm 10\%$ , M:  $\pm 20\%$
- Isat: For Inductance drop 10% from its value without current.

### Features

- Low Profile
- Low DCR
- Large Current Adaptable
- High Frequency (up to 1MHz)

### Applications

- Desktop/Laptop/Notebook Computers
- Portable Servers/Terminals/Workstations
- Thin type on-board power supply module for exchanger
- DC/DC converter in distributed power systems or VRM applicatins
- Inductor for general purpose use



### Shape & Dimensions

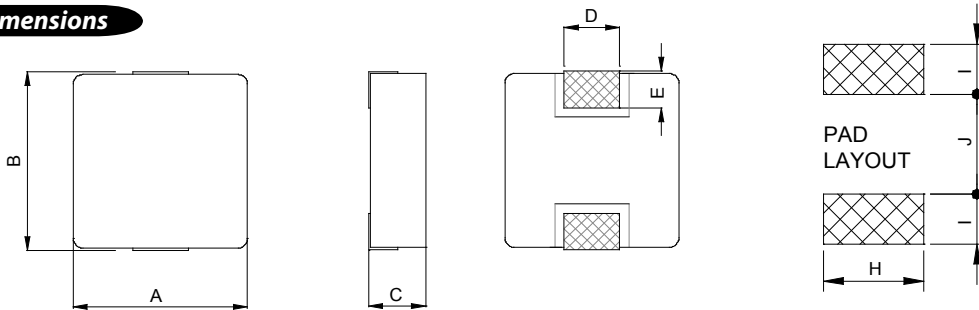

TYPE	A (mm)	B (mm)	C (mm)	D (mm)	E (mm)	H (Ref.)	I (Ref.)	J (Ref.)
AMPI0630BD	6.9 MAX.	7.1±0.3	3.0 MAX.	3.0±0.3	1.6±0.5	3.5	1.85	3.7
AMPI0630ED	6.9 MAX.	7.1±0.3	3.0 MAX.	3.0±0.3	1.6±0.5	3.5	1.85	3.7
AMPI0630GD	6.9 MAX.	7.1±0.3	3.0 MAX.	3.0±0.3	1.6±0.5	3.5	1.85	3.7
AMPI1040BD	10.5±0.5	11.5±1.0	4.0 MAX.	3.0 REF	2.3 REF	4.0	3.50	6.0
AMPI1040ED	10.5±0.5	11.5±1.0	4.0 MAX.	3.0 REF	2.3 REF	4.0	3.50	6.0
AMPI1240BD	12.8±0.5	13.5±1.0	4.0 MAX.	2.5 REF	2.5 REF	5.0	4.50	6.0
AMPI1265BD	12.8±0.5	13.2±1.0	6.5 MAX.	3.8 REF	2.5 REF	5.0	4.50	6.0

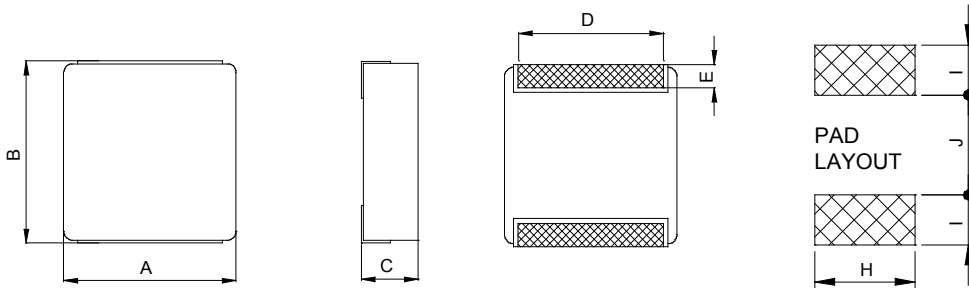

TYPE	A (mm)	B (mm)	C (mm)	D (mm)	E (mm)	H (Ref.)	I (Ref.)	J (Ref.)
AMPI1770BD	17.15 MAX.	18±0.3	7.0 MAX.	11.94±0.3	2.11±0.3	12.09	3.175	11.68
AMPI1770ED	17.15 MAX.	18±0.3	7.0 MAX.	11.94±0.3	2.11±0.3	12.09	3.175	11.68

### Product Identification

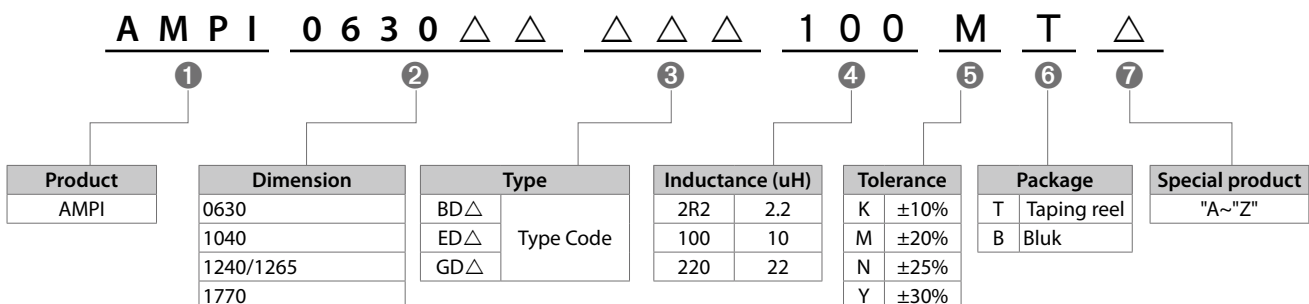

### Specification

Part Number	Inductance (H)	Test Freq. (Hz)	DCR (Ω) Max.	Saturation Current (A) Typ.	Temp. Rise current (A) Typ.
<b>AMPI0630BD Series Specification</b>					
AMPI0630BDR10 T	0.10u	100 K	1.7 m	60.0	32.5
AMPI0630BDR15 T	0.15u	100 K	2.5 m	52.0	26.0
AMPI0630BDR20 T	0.20u	100 K	3.0 m	41.0	24.0
AMPI0630BDR22 T	0.22u	100 K	2.8 m	40.0	23.0
AMPI0630BDR33 T	0.33u	100 K	3.9 m	30.0	20.0
AMPI0630BDR47 T	0.47u	100 K	4.2 m	26.0	17.5
AMPI0630BDR68 T	0.68u	100 K	5.5 m	25.0	15.5
AMPI0630BDR82 T	0.82u	100 K	8.0 m	24.0	13.0
AMPI0630BD1R0 T	1.0u	100 K	10.0 m	22.0	11.0
AMPI0630BD1R5 T	1.5u	100 K	15.0 m	15.0	9.0
AMPI0630BD2R2 T	2.2u	100 K	20.0 m	14.0	8.0
AMPI0630BD3R3 T	3.3u	100 K	30.0 m	13.5	6.0
AMPI0630BD4R7 T	4.7u	100 K	40.0 m	9.0	5.5
AMPI0630BD6R8 T	6.8u	100 K	60.0 m	8.0	4.5
AMPI0630BD8R2 T	8.2u	100 K	68.0 m	7.5	4.0
AMPI0630BD100 T	10u	100 K	105.0 m	7.0	3.0
<b>AMPI0630ED Series Specification</b>					
AMPI0630ED1R0□T	1.0u	100 K	8.0 m	9.5	12.5
AMPI0630ED1R5□T	1.5u	100 K	12.5 m	8.0	10.5
AMPI0630ED2R2□T	2.2u	100 K	16.5 m	7.0	9.0
AMPI0630ED3R3□T	3.3u	100 K	26.0 m	6.5	7.0
AMPI0630ED4R7□T	4.7u	100 K	33.4 m	4.0	6.0
AMPI0630ED6R8□T	6.8u	100 K	46.8 m	4.0	5.5
AMPI0630ED8R2□T	8.2u	100 K	54.9 m	4.0	5.0
AMPI0630ED100□T	10u	100 K	71.2 m	3.5	4.0
AMPI0630ED220□T	22u	100 K	135.0 m	2.5	2.9
<b>AMPI0630GD Series Specification</b>					
AMPI0630GDR10□T	0.10u	100 K	1.7 m	60.0	32.5
AMPI0630GDR15□T	0.15u	100 K	2.5 m	40.0	30.0
AMPI0630GDR20□T	0.20u	100 K	3.0 m	34.0	24.0
AMPI0630GDR22□T	0.22u	100 K	3.0 m	34.0	23.0
AMPI0630GDR33□T	0.33u	100 K	3.5 m	25.0	21.0
AMPI0630GDR36□T	0.36u	100 K	3.9 m	24.0	20.0
AMPI0630GDR47□T	0.47u	100 K	4.1 m	20.0	18.0
AMPI0630GDR56□T	0.56u	100 K	4.5 m	18.0	16.5
AMPI0630GDR68□T	0.68u	100 K	5.3 m	17.0	16.0
AMPI0630GDR82□T	0.82u	100 K	6.0 m	16.0	14.0
AMPI0630GD1R0□T	1.0u	100 K	7.4 m	15.0	12.0
AMPI0630GD1R2□T	1.2u	100 K	10.0 m	14.0	10.0
AMPI0630GD1R5□T	1.5u	100 K	12.1 m	14.0	10.0
AMPI0630GD2R2□T	2.2u	100 K	15.0 m	10.0	8.0
AMPI0630GD2R5□T	2.5u	100 K	18.0 m	10.0	7.0
AMPI0630GD3R3□T	3.3u	100 K	22.0 m	9.5	6.5
AMPI0630GD4R7□T	4.7u	100 K	33.0 m	6.5	5.5
AMPI0630GD5R6□T	5.6u	100 K	42.0 m	6.0	5.5
AMPI0630GD6R8□T	6.8u	100 K	50.0 m	6.0	4.5
AMPI0630GD8R2□T	8.2u	100 K	60.0 m	6.0	4.5
AMPI0630GD100□T	10u	100 K	68.0 m	5.5	4.0

#### NOTE:

- The operating temperature range is -40°C to +125°C
- □ Tolerance M: ±20%, N: ±25%
- Isat: For Inductance drop approximately 30% from its value without current.
- Irms: Typical Heat Rating D.C. current would cause an approximately ΔT of 40°C

### Specification

Part Number	Inductance (H)	Test Freq. (Hz)	DCR (Ω) Max.	Saturation Current (A) Typ.	Temp. Rise current (A) Typ.
<b>AMPI1040BD Series Specification</b>					
AMPI1040BDR19□T	0.19u	100 K	0.60 m	44	44
AMPI1040BDR24□T	0.24u	100 K	0.80 m	38	38
AMPI1040BDR36□T	0.36u	100 K	0.95 m	35	35
AMPI1040BDR47□T	0.47u	100 K	1.4 m	32	32
AMPI1040BDR56□T	0.56u	100 K	1.5 m	30	30
AMPI1040BDR78□T	0.78u	100 K	1.7 m	25	25
AMPI1040BD1R0□T	1.0u	100 K	2.5 m	20	20
AMPI1040BD1R8□T	1.8u	100 K	5.0 m	15	15
AMPI1040BD2R0□T	2.0u	100 K	5.8 m	14	14
AMPI1040BD2R2□T	2.2u	100 K	6.3 m	14	16
<b>AMPI1040ED Series Specification</b>					
AMPI1040EDR19□T	0.19u	100 K	0.8 m	60	38
AMPI1040EDR22□T	0.22u	100 K	0.8 m	50	38
AMPI1040EDR36□T	0.36u	100 K	1.2 m	50	30
AMPI1040EDR47□T	0.47u	100 K	1.7 m	45	28
AMPI1040EDR56□T	0.56u	100 K	1.8 m	40	25
AMPI1040EDR68□T	0.68u	100 K	1.8 m	30	25
AMPI1040ED1R0□T	1.0u	100 K	3.2 m	30	21
AMPI1040ED1R5□T	1.5u	100 K	5.0 m	20	15
AMPI1040ED2R5□T	2.5u	100 K	9.5 m	18	13
<b>AMPI1240BD Series Specification</b>					
AMPI1240BDR10□T	0.1u	100 K	1.1 m	75	43.0
AMPI1240BDR22□T	0.22u	100 K	1.4 m	70	41.0
AMPI1240BDR33□T	0.33u	100 K	1.5 m	60	38.0
AMPI1240BDR47□T	0.47u	100 K	1.9 m	55	32.0
AMPI1240BDR60□T	0.60u	100 K	2.3 m	50	30.0
AMPI1240BDR68□T	0.68u	100 K	2.5 m	46	28.0
AMPI1240BDR82□T	0.82u	100 K	3.1 m	44	25.0
AMPI1240BD0R9□T	0.9u	100 K	3.5 m	40	24.0
AMPI1240BD1R0□T	1.0u	100 K	3.7 m	38	24.0
AMPI1240BD1R2□T	1.2u	100 K	3.7 m	25	20.0
AMPI1240BD1R5□T	1.5u	100 K	6.0 m	30	19.0
AMPI1240BD1R8□T	1.8u	100 K	7.6 m	26	16.0
AMPI1240BD2R2□T	2.2u	100 K	7.6 m	22	16.0
AMPI1240BD3R3□T	3.3u	100 K	8.4 m	20	14.0
AMPI1240BD4R7□T	4.7u	100 K	12 m	15	11.0
<b>AMPI1265BD Series Specification</b>					
AMPI1265BDR10□T	0.10u	100 K	0.50 m	120	60
AMPI1265BDR15□T	0.15u	100 K	0.60 m	118	55
AMPI1265BDR22□T	0.22u	100 K	0.70 m	112	53
AMPI1265BDR30□T	0.30u	100 K	0.80 m	72	48
AMPI1265BDR33□T	0.33u	100 K	0.90 m	65	46
AMPI1265BDR40□T	0.40u	100 K	1.00 m	64	44
AMPI1265BDR47□T	0.47u	100 K	1.20 m	63	41
AMPI1265BDR56□T	0.56u	100 K	1.40 m	62	37
AMPI1265BDR68□T	0.68u	100 K	1.60 m	60	35
AMPI1265BDR82□T	0.82u	100 K	1.90 m	50	33
AMPI1265BD1R0□T	1.0u	100 K	2.00 m	49	32
AMPI1265BD1R2□T	1.2u	100 K	2.50 m	48	30
AMPI1265BD1R5□T	1.5u	100 K	3.00 m	45	27
AMPI1265BD1R8□T	1.8u	100 K	3.20 m	41	24
AMPI1265BD2R2□T	2.2u	100 K	4.20 m	40	22
AMPI1265BD3R3□T	3.3u	100 K	6.80 m	35	18
AMPI1265BD4R7□T	4.7u	100 K	11.20 m	30	13.5

#### NOTE:

- The operating temperature range is -40°C to +125°C
- □ Tolerance M: ±20%, N: ±25%
- Isat: For Inductance drop approximately 30% from its value without current.
- Irms: Typical Heat Rating D.C. current would cause an approximately ΔT of 40°C

### Specification

Part Number	Inductance (H)	Test Freq. (Hz)	DCR ( $\Omega$ ) Max.	Saturation Current (A) Typ.	Temp. Rise current (A) Typ.
<b>AMPI1265BD Series Specification</b>					
AMPI1265BD5R6□T	5.6u	100 K	10.0 m	26.5	13.5
AMPI1265BD6R8□T	6.8u	100 K	14.00 m	16.5	11.5
AMPI1265BD8R2□T	8.2u	100 K	15.50 m	16	10.5
AMPI1265BD100□T	10u	100 K	16.80 m	15.5	10.0
AMPI1265BD150□T	15u	100 K	31 m	12	6.5
AMPI1265BD220□T	22u	100 K	40 m	12	6.0
AMPI1265BD330□T	33u	100 K	60 m	10	5.0
AMPI1265BD470□T	47u	100 K	92 m	5.0	4.0
AMPI1265BD680□T	68u	100 K	75 m	3.5	2.0
AMPI1265BD101□T	100u	100 K	140 m	2.0	1.0
<b>AMPI1770BD Series Specification</b>					
AMPI1770BDR33□T	0.33u	100 K	0.67 m	55.0	75.5
AMPI1770BDR47□T	0.47u	100 K	0.87 m	62.0	64.5
AMPI1770BDR56□T	0.56u	100 K	0.91 m	66.0	61.0
AMPI1770BDR82□T	0.82u	100 K	1.08 m	45.0	56.5
AMPI1770BD1R0□T	1.0u	100 K	1.27 m	32.0	55.5
AMPI1770BD1R5□T	1.5u	100 K	1.62 m	31.0	48.0
AMPI1770BD2R2□T	2.2u	100 K	1.98 m	28.0	43.5
AMPI1770BD3R3□T	3.3u	100 K	2.93 m	27.0	35.0
AMPI1770BD4R7□T	4.7u	100 K	4.18 m	21.0	30.0
AMPI1770BD5R6□T	5.6u	100 K	4.44 m	21.0	28.0
AMPI1770BD6R8□T	6.8u	100 K	6.15 m	18.5	22.5
AMPI1770BD8R2□T	8.2u	100 K	8.10 m	18.0	21.0
AMPI1770BD100□T	10u	100 K	9.33 m	17.0	19.0
AMPI1770BD150□T	15u	100 K	14.4 m	12.0	14.0
AMPI1770BD220□T	22u	100 K	21.0 m	9.5	12.0
AMPI1770BD330□T	33u	100 K	37.0 m	9.0	10.7
AMPI1770BD470□T	47u	100 K	42.7 m	8.6	8.7
AMPI1770BD560□T	56u	100 K	57.8 m	4.2	7.2
AMPI1770BD680□T	68u	100 K	75.7 m	4.5	6.1
AMPI1770BD820□T	82u	100 K	91.7 m	4.5	5.5
AMPI1770BD101□T	100u	100 K	110.0 m	4.0	5.0
<b>AMPI1770ED Series Specification</b>					
AMPI1770EDR22□T	0.22u	100 K	0.70 m	129.0	80.0
AMPI1770EDR33□T	0.33u	100 K	0.79 m	126.0	65.0
AMPI1770EDR47□T	0.47u	100 K	0.92 m	123.0	62.0
AMPI1770EDR56□T	0.56u	100 K	1.00 m	88.0	56.0
AMPI1770EDR82□T	0.82u	100 K	1.29 m	73.0	50.0
AMPI1770ED1R0□T	1.0u	100 K	1.35 m	73.0	48.0
AMPI1770ED1R5□T	1.5u	100 K	1.88 m	65.0	42.0
AMPI1770ED1R8□T	1.8u	100 K	2.07 m	65.0	38.0
AMPI1770ED2R2□T	2.2u	100 K	2.53 m	62.0	35.0
AMPI1770ED3R3□T	3.3u	100 K	3.88 m	54.0	28.0
AMPI1770ED4R7□T	4.7u	100 K	5.11 m	41.0	25.0
AMPI1770ED5R6□T	5.6u	100 K	7.05 m	40.0	21.0
AMPI1770ED6R8□T	6.8u	100 K	8.83 m	32.0	19.0
AMPI1770ED8R2□T	8.2u	100 K	10.66 m	25.0	18.0
AMPI1770ED100□T	10u	100 K	12.0 m	25.0	16.5
AMPI1770ED150□T	15u	100 K	19.9 m	25.0	12.5
AMPI1770ED220□T	22u	100 K	26.5 m	23.0	11.0

#### NOTE:

- The operating temperature range is -40°C to +125°C
- $I_{sat}$ : For Inductance drop approximately 30% from its value without current.
- $I_{rms}$ : Typical Heat Rating D.C. current would cause an approximately  $\Delta T$  of 40°C
- □ Tolerance M:  $\pm 20\%$ , N:  $\pm 25\%$

**Features**

- Lowest height in this package footprint.
- Lowest DCR/μH, in this package size.
- Handles high transient current spikes without saturation.
- ultra low buzz noise, due to composite construction.
- The products contain no lead and also support lead-free soldering.

**Applications**

Excellent for power line DC-DC conversion applications used in power switching, personal computers and other handheld electronic equipment.



**Shape & Dimensions**

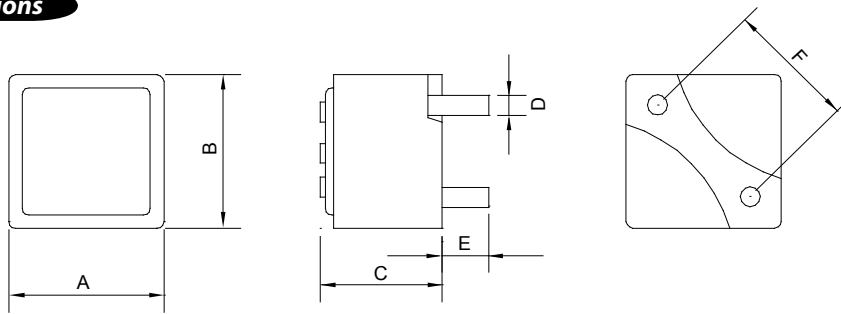

TYPE	A (mm)	B (mm)	C (mm)	D (mm)	E (mm)	F (mm)
ADIP1109EP	11.0±0.5	11.0±0.5	by each P/N	by each P/N	3.5±0.5	8.5±0.5

**Product Identification**

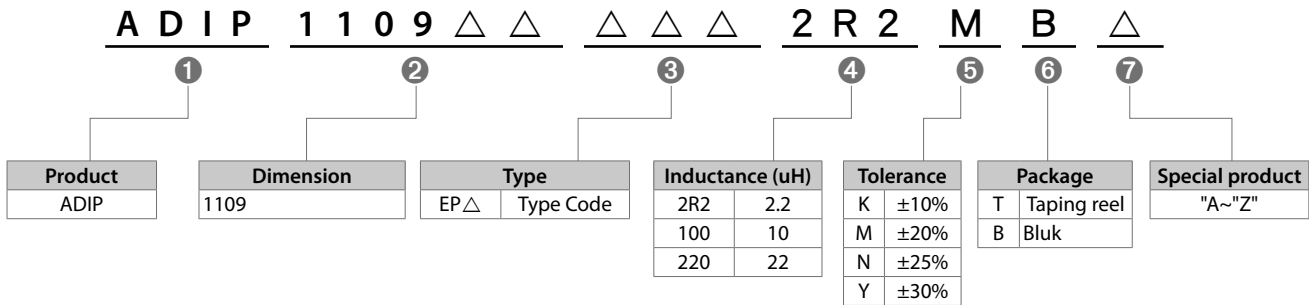

**Specification**

Part Number	Inductance (H)	Test Freq. (Hz)	DCR (Ω) Max.	Saturation Current (A) Typ.	Temp. Rise current (A) Typ.
<b>ADIP1109EP Series Specification</b>					
ADIP1109EPR47□B	0.47u	100 K	1.0 m	60	40
ADIP1109EPR60□B	0.6u	100 K	1.0 m	50	40
ADIP1109EP1R0□B	1.0u	100 K	1.8 m	45	25
ADIP1109EP1R2□B	1.2u	100 K	2.0 m	33	23
ADIP1109EP1R5□B	1.5u	100 K	2.5 m	32	21
ADIP1109EP2R0□B	2.0u	100 K	4.0 m	27	15
ADIP1109EP2R2□B	2.2u	100 K	5.0 m	40	15

**NOTE:**

- The operating temperature range is -25°C to +125°C
- Isat:For Inductance drop approximately 20% from its value without current.
- Irms:Typical Heat Rating D.C. current would cause an approximately ΔT of 40°C
- □ Tolerance M: ±20%, N: ±25%, Y: ±30%



**Features**

Miniature SMD chip inductors have been designed especially for the need of today's high frequency designer. Their ceramic construction delivers the highest possible SRFs as well as excellent Q values. The non-magnetic coil form also assure the utmost in thermal stability, predictability, and batch consistency.

**Applications**

Pager, Cordless phone & High Freq. Communication Products.



**Shape & Dimensions**

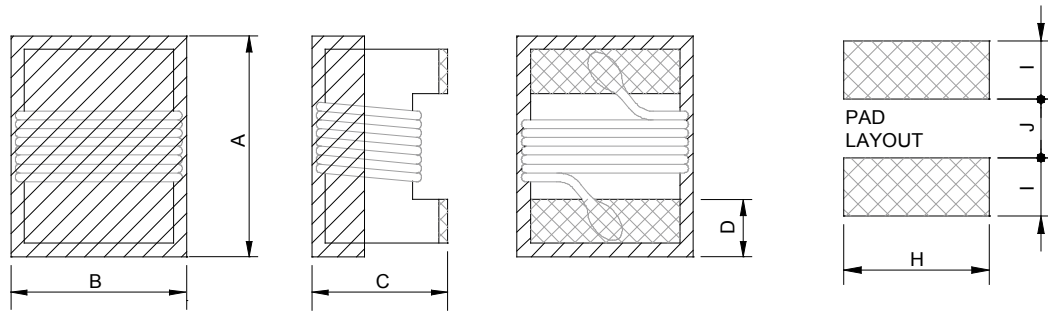

TYPE	A (mm)	B (mm)	C (mm)	D (mm)	H (Ref.)	I (Ref.)	J (Ref.)
AOI1005C	1.19 MAX.	0.7 MAX.	0.66 MAX.	0.23 Ref.	0.66	0.36	0.46
AOI1608CN	1.8 MAX.	1.2 MAX.	1.02 MAX.	0.33 Ref.	1.02	0.64	0.64
AOI2012CN	2.4 MAX.	1.65 MAX.	1.45 MAX.	0.44 Ref.	1.78	1.02	0.76
AOI2520CN	2.9 MAX.	2.54 MAX.	2.03 MAX.	0.45±0.1	2.54	1.02	1.27
AOI2012FN	2.4 MAX.	1.65 MAX.	1.45 MAX.	0.44 Ref.	1.78	1.02	0.76
AOI2520FN	2.9 MAX.	2.54 MAX.	2.03 MAX.	0.5±0.1	2.54	1.02	1.27
AOI3225FN	3.6 MAX.	2.9 MAX.	2.4 MAX.	0.5±0.1	2.70	1.20	2.00

**Product Identification**

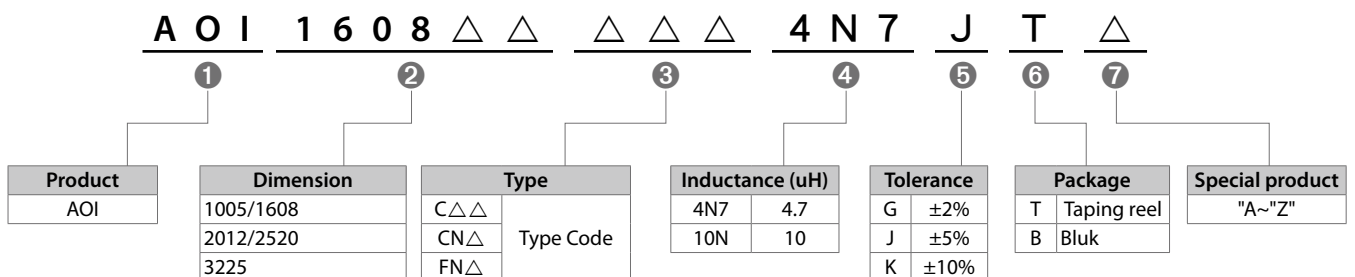

### Specification

Part Number	Inductance (uH)/MHz	Inductance Tolerance	Q (Min.)/MHz	SRF(Min.) (MHz)	DCR (Ω) Max.	Irms (mA) Max.
<b>AOI1005C Series Specification</b>						
AOI1005C1N0□T	1.0/250	J, K	16/250	12700	0.045	1360
AOI1005C1N9□T	1.9/250	J, K	16/250	11300	0.070	1040
AOI1005C2N0□T	2.0/250	J, K	16/250	11100	0.070	1040
AOI1005C2N2□T	2.2/250	J, K	19/250	10800	0.070	960
AOI1005C2N4□T	2.4/250	J, K	15/250	10500	0.068	790
AOI1005C2N7□T	2.7/250	J, K	16/250	10400	0.120	640
AOI1005C3N3□T	3.3/250	J, K	19/250	7000	0.066	840
AOI1005C3N6□T	3.6/250	J, K	19/250	6800	0.066	840
AOI1005C3N9□T	3.9/250	J, K	19/250	6000	0.066	840
AOI1005C4N3□T	4.3/250	J, K	18/250	6000	0.091	700
AOI1005C4N7□T	4.7/250	J, K	15/250	4770	0.130	640
AOI1005C5N1□T	5.1/250	J, K	20/250	4800	0.083	800
AOI1005C5N6□T	5.6/250	J, K	20/250	4800	0.083	760
AOI1005C6N2□T	6.2/250	J, K	20/250	4800	0.083	760
AOI1005C6N8□T	6.8/250	J, K	20/250	4800	0.083	680
AOI1005C7N5□T	7.5/250	J, K	22/250	4800	0.100	680
AOI1005C8N2□T	8.2/250	J, K	22/250	4400	0.100	680
AOI1005C8N7□T	8.7/250	J, K	18/250	4100	0.200	480
AOI1005C9N0□T	9.0/250	J, K	22/250	4160	0.100	680
AOI1005C9N1□T	9.1/250	J, K	22/250	4160	0.100	680
AOI1005C9N5□T	9.5/250	J, K	18/250	4000	0.200	480
AOI1005C10N□T	10/250	J, K	21/250	3900	0.200	480
AOI1005C11N□T	11/250	J, K	24/250	3680	0.120	640
AOI1005C12N□T	12/250	J, K	24/250	3600	0.120	640
AOI1005C13N□T	13/250	J, K	24/250	3450	0.210	440
AOI1005C15N□T	15/250	J, K	24/250	3280	0.170	560
AOI1005C16N□T	16/250	J, K	24/250	3100	0.220	560
AOI1005C18N□T	18/250	J, K	25/250	3100	0.230	420
AOI1005C19N□T	19/250	J, K	24/250	3040	0.200	480
AOI1005C20N□T	20/250	J, K	25/250	3000	0.250	420
AOI1005C22N□T	22/250	J, K	25/250	2800	0.300	400
AOI1005C23N□T	23/250	J, K	22/250	2720	0.300	400
AOI1005C24N□T	24/250	J, K	25/250	2700	0.300	400
AOI1005C27N□T	27/250	J, K	24/250	2480	0.300	400
AOI1005C30N□T	30/250	J, K	25/250	2350	0.350	400
AOI1005C33N□T	33/250	J, K	24/250	2350	0.400	400
AOI1005C36N□T	36/250	J, K	24/250	2320	0.440	320
AOI1005C39N□T	39/250	J, K	25/250	2100	0.550	200
AOI1005C40N□T	40/250	J, K	24/250	2240	0.440	320
AOI1005C43N□T	43/250	J, K	25/250	2030	0.810	100
AOI1005C47N□T	47/250	J, K	20/250	2100	0.830	150
AOI1005C51N□T	51/250	J, K	25/250	1750	0.820	100
AOI1005C56N□T	56/250	J, K	22/250	1760	0.970	100
AOI1005C68N□T	68/250	J, K	22/250	1620	1.120	100
AOI1005C82N□T	82/250	J, K	20/250	1260	1.55	50
AOI1005CR10□T	100/250	J, K	20/250	1160	2.0	30

#### NOTE:

- The operating temperature range is -40°C to +125°C
- □ Tolerance J: ±5%, K: ±10%
- Irms for 15°C rise above 25°C ambient.

## Specification

Part Number	Inductance (uH)/MHz	Inductance Tolerance	Q (Min.)/MHz	900 MHz		1.7 GHz		SRF(Min.) (MHz)	DCR (Ω) Max.	Irms (mA) Max.
				L Typ.	Q Typ.	L Typ.	Q Typ.			
<b>AOI1608CN Series Specification</b>										
AOI1608CN1N6□T	1.6/250	J, K	24/250	1.61	72.86	1.61	89.61	12500	0.030	700
AOI1608CN1N8□T	1.8/250	J, K	16/250	1.77	46.55	1.77	59.72	12500	0.045	700
AOI1608CN2N2□T	2.2/250	J, K	13/250	2.14	26.03	2.13	34.11	12500	0.250	700
AOI1608CN3N3□T	3.3/250	J, K	30/250	3.42	73.45	3.46	95.36	5900	0.045	700
AOI1608CN3N6□T	3.6/250	J, K	22/250	3.68	64.20	3.73	82.77	5900	0.063	700
AOI1608CN3N9□T	3.9/250	J, K	22/250	3.90	50.11	3.94	67.32	6900	0.080	700
AOI1608CN4N3□T	4.3/250	J, K	22/250	4.44	67.50	4.59	81.57	5900	0.063	700
AOI1608CN4N7□T	4.7/250	J, K	20/250	4.65	58.79	4.75	75.36	5800	0.085	700
AOI1608CN5N1□T	5.1/250	J, K	20/250	5.07	54.50	5.21	70.06	5700	0.115	700
AOI1608CN5N6□T	5.6/250	J, K	18/250	5.48	43.67	5.66	55.16	5800	0.160	700
AOI1608CN6N3□T	6.3/250	J, K	26/250	6.54	68.68	6.71	88.51	5700	0.115	700
AOI1608CN6N8□T	6.8/250	J, K	27/250	6.89	62.87	7.08	82.33	5800	0.125	700
AOI1608CN7N5□T	7.5/250	J, K	28/250	7.57	65.18	7.84	85.57	4800	0.115	700
AOI1608CN8N2□T	8.2/250	J, K	30/250	8.13	65.01	8.47	82.23	4700	0.125	700
AOI1608CN8N7□T	8.7/250	J, K	28/250	8.76	63.94	9.22	76.37	4600	0.109	700
AOI1608CN9N1□T	9.1/250	J, K	28/250	9.208	62.29	9.77	75.88	4600	0.120	700
AOI1608CN9N5□T	9.5/250	J, K	28/250	9.79	62.25	10.58	69.16	5400	0.145	700
AOI1608CN10N□T	10/250	G, J, K	31/250	10.36	69.22	10.81	90.90	4800	0.145	700
AOI1608CN11N□T	11/250	G, J, K	30/250	11.22	67.67	11.80	85.69	4000	0.145	700
AOI1608CN12N□T	12/250	G, J, K	35/250	12.37	69.26	13.22	83.39	4000	0.145	700
AOI1608CN15N□T	15/250	G, J, K	35/250	15.22	76.65	16.37	88.93	4000	0.180	700
AOI1608CN16N□T	16/250	G, J, K	34/250	16.60	79.11	18.38	79.94	3300	0.170	700
AOI1608CN18N□T	18/250	G, J, K	35/250	18.44	76.19	20.05	80.07	3100	0.180	700
AOI1608CN19N□T	19/250	G, J, K	35/250	19.71	73.77	23.35	62.78	3000	0.190	700
AOI1608CN20N□T	20/250	G, J, K	38/250	20.50	79.78	23.27	86.77	3000	0.180	700
AOI1608CN22N□T	22/250	G, J, K	38/250	22.66	78.78	25.67	83.99	3000	0.205	700
AOI1608CN23N□T	23/250	G, J, K	38/250	24.19	70.88	28.48	72.86	2850	0.205	700
AOI1608CN24N□T	24/250	G, J, K	36/250	25.74	70.93	31.01	63.21	2650	0.205	700
AOI1608CN25N□T	25/250	G, J, K	38/250	25.93	84.76	29.73	89.52	2800	0.210	600
AOI1608CN27N□T	27/250	G, J, K	40/250	29.03	59.83	37.43	46.06	2800	0.220	600
AOI1608CN30N□T	30/250	G, J, K	37/250	32.91	68.96	41.66	59.67	2250	0.220	600
AOI1608CN33N□T	33/250	G, J, K	40/250	35.72	61.57	47.39	50.44	2300	0.240	600
AOI1608CN36N□T	36/250	G, J, K	37/250	39.45	64.02	50.92	59.84	2080	0.250	600
AOI1608CN39N□T	39/250	G, J, K	40/250	42.71	61.22	58.42	47.55	2200	0.260	600
AOI1608CN43N□T	43/250	G, J, K	38/250	47.21	62.53	64.17	53.05	2000	0.280	600
AOI1608CN47N□T	47/200	G, J, K	38/200	51.82	52.98	77.03	39.17	2000	0.280	600
AOI1608CN51N□T	51/200	G, J, K	38/250	59.27	50.95	103.80	23.61	2130	0.300	600
AOI1608CN56N□T	56/200	G, J, K	38/200	64.38	51.47	108.1	28.82	1900	0.310	600
AOI1608CN62N□T	62/200	G, J, K	37/200	73.30	42.68	156.50	16.15	1800	0.330	600
AOI1608CN68N□T	68/200	G, J, K	37/200	80.23	44.33	174.00	18.31	1700	0.340	600
AOI1608CN72N□T	72/150	G, J, K	34/150	86.67	41.11	212.9	15.59	1700	0.490	400
AOI1608CN82N□T	82/150	G, J, K	34/150	101.20	37.88	300.60	11.78	1700	0.540	400
AOI1608CN91N□T	91/150	G, J, K	34/150	111.80	49.36	-	-	1500	0.560	400
AOI1608CNR10□T	100/150	G, J, K	34/150	126.90	36.13	-	-	1400	0.580	400
AOI1608CNR11□T	110/150	G, J, K	32/150	146.80	34.58	-	-	1350	0.610	300
AOI1608CNR12□T	120/150	G, J, K	32/150	166.80	28.57	-	-	1300	0.750	300
AOI1608CNR13□T	130/150	G, J, K	32/150	180.10	36.93	-	-	1200	0.750	280
AOI1608CNR15□T	150/150	G, J, K	28/150	234.90	21.92	-	-	990	0.920	280
AOI1608CNR17□T	170/100	G, J, K	25/100	228.40	34.96	-	-	990	1.150	240
AOI1608CNR18□T	180/100	G, J, K	25/100	289.10	19.93	-	-	990	1.250	240
AOI1608CNR19□T	190/100	G, J, K	25/100	279.10	30.83	-	-	990	1.350	200
AOI1608CNR20□T	200/100	G, J, K	25/100	-	-	-	-	990	1.500	200
AOI1608CNR22□T	220/100	G, J, K	25/100	-	-	-	-	900	1.700	200
AOI1608CNR24□T	240/100	G, J, K	25/100	-	-	-	-	900	1.700	200
AOI1608CNR27□T	270/100	G, J, K	24/100	-	-	-	-	900	2.000	170
AOI1608CNR33□T	330/100	G, J, K	25/100	-	-	-	-	900	2.750	100
AOI1608CNR34□T	340/100	G, J, K	25/100	-	-	-	-	900	2.900	100
AOI1608CNR39□T	390/100	G, J, K	25/100	-	-	-	-	900	3.150	100
AOI1608CNR47□T	470/100	G, J, K	25/100	-	-	-	-	750	4.000	80

### NOTE:

- The operating temperature range is -40°C to +125°C
- □ Tolerance G: ±2%, J: ±5%, K: ±10%
- Irms for 15°C rise above 25°C ambient.

## Specification

Part Number	Inductance (uH)/MHz	Inductance Tolerance	Q (Min.)/MHz	SRF(Min.) (MHz)	DCR (Ω) Max.	Irms (mA) Max.
<b>AOI2012CN Sreies Specification</b>						
AOI2012CN2N8□T	2.8/250	J, K	55/1500	7900	0.06	800
AOI2012CN3N0□T	3.0/250	J, K	55/1500	7900	0.08	800
AOI2012CN3N3□T	3.3/250	J, K	45/1500	7900	0.12	600
AOI2012CN5N1□T	5.1/250	J, K	60/1000	5800	0.06	600
AOI2012CN5N6□T	5.6/250	J, K	65/1000	5500	0.08	600
AOI2012CN6N2□T	6.2/250	J, K	50/1000	5500	0.11	800
AOI2012CN6N8□T	6.8/250	J, K	50/1000	5500	0.11	600
AOI2012CN7N5□T	7.5/250	J, K	50/1000	4500	0.14	600
AOI2012CN8N2□T	8.2/250	J, K	50/1000	4700	0.16	600
AOI2012CN8N7□T	8.7/250	J, K	50/500	4700	0.23	600
AOI2012CN10N□T	10/250	G, J, K	60/500	4200	0.10	600
AOI2012CN12N□T	12/250	G, J, K	50/500	4000	0.15	600
AOI2012CN15N□T	15/250	G, J, K	50/500	3400	0.17	600
AOI2012CN18N□T	18/250	G, J, K	50/500	3300	0.20	600
AOI2012CN22N□T	22/250	G, J, K	55/500	2600	0.22	500
AOI2012CN24N□T	24/250	G, J, K	50/500	2000	0.22	500
AOI2012CN27N□T	27/250	G, J, K	55/500	2500	0.25	500
AOI2012CN33N□T	33/250	G, J, K	60/500	2050	0.27	500
AOI2012CN36N□T	36/250	G, J, K	55/500	1700	0.27	500
AOI2012CN39N□T	39/250	G, J, K	60/500	2000	0.29	500
AOI2012CN43N□T	43/200	G, J, K	60/500	1650	0.34	500
AOI2012CN47N□T	47/200	G, J, K	60/500	1650	0.31	500
AOI2012CN56N□T	56/200	G, J, K	60/500	1550	0.34	500
AOI2012CN68N□T	68/200	G, J, K	60/500	1450	0.38	500
AOI2012CN75N□T	75/200	G, J, K	60/500	1400	0.40	400
AOI2012CN82N□T	82/150	G, J, K	65/500	1300	0.42	400
AOI2012CN91N□T	91/150	G, J, K	65/500	1200	0.48	400
AOI2012CNR10□T	100/150	G, J, K	65/500	1200	0.46	400
AOI2012CNR11□T	110/150	G, J, K	50/250	1000	0.48	400
AOI2012CNR12□T	120/150	G, J, K	50/250	1100	0.51	400
AOI2012CNR15□T	150/100	G, J, K	50/250	920	0.56	400
AOI2012CNR16□T	160/100	G, J, K	50/250	900	0.60	400
AOI2012CNR18□T	180/100	G, J, K	50/250	870	0.64	400
AOI2012CNR20□T	200/100	G, J, K	50/250	865	0.68	400
AOI2012CNR22□T	220/100	G, J, K	50/250	850	0.70	400
AOI2012CNR24□T	240/100	G, J, K	44/250	690	1.00	350
AOI2012CNR25□T	250/100	G, J, K	48/250	680	1.00	350
AOI2012CNR27□T	270/100	G, J, K	48/250	650	1.00	350
AOI2012CNR33□T	330/100	G, J, K	48/250	750	1.40	310
AOI2012CNR39□T	390/100	G, J, K	48/250	560	1.50	290
AOI2012CNR43□T	430/50	G, J, K	33/100	430	1.70	270
AOI2012CNR47□T	470/50	G, J, K	30/100	375	1.76	250
AOI2012CNR56□T	560/25	G, J, K	23/50	340	1.90	230
AOI2012CNR62□T	620/25	G, J, K	23/50	220	2.20	210
AOI2012CNR68□T	680/25	G, J, K	23/50	188	2.20	190
AOI2012CNR75□T	750/25	G, J, K	23/50	200	2.30	180
AOI2012CNR82□T	820/25	G, J, K	23/50	215	2.35	180
AOI2012CN1R0□T	1000/25	G, J, K	22/50	200	2.45	180
AOI2012CN1R2□T	1200/7.9	G, J, K	16/7.9	160	2.45	170
AOI2012CN1R5□T	1500/7.9	G, J, K	16/7.9	120	2.50	170
AOI2012CN1R8□T	1800/7.9	G, J, K	16/7.9	80	2.50	170
AOI2012CN2R2□T	2200/7.9	G, J, K	16/7.9	60	2.70	160
AOI2012CN2R7□T	2700/7.9	G, J, K	16/7.9	50	3.80	160

### NOTE:

- The operating temperature range is -40°C to +125°C
- □ Tolerance G: ±2%, J: ±5%, K: ±10%
- I<sub>rms</sub> for 15°C rise above 25°C ambient.

### Specification

Part Number	Inductance (uH)/MHz	Inductance Tolerance	Q (Min.)/MHz	SRF(Min.) (MHz)	DCR (Ω) Max.	Irms (mA) Max.
<b>AOI2520CN Sreies Specification</b>						
AOI2520CN10N□T	10/50	G, J, K	50/500	4100	0.08	1000
AOI2520CN12N□T	12/50	G, J, K	50/500	3300	0.09	1000
AOI2520CN15N□T	15/50	G, J, K	45/500	2500	0.10	1000
AOI2520CN18N□T	18/50	G, J, K	50/350	2500	0.11	1000
AOI2520CN22N□T	22/50	G, J, K	55/350	2400	0.12	1000
AOI2520CN27N□T	27/50	G, J, K	55/350	1600	0.13	1000
AOI2520CN33N□T	33/50	G, J, K	60/350	1600	0.14	1000
AOI2520CN39N□T	39/50	G, J, K	60/350	1500	0.15	1000
AOI2520CN47N□T	47/50	G, J, K	65/350	1500	0.16	1000
AOI2520CN56N□T	56/50	G, J, K	65/350	1300	0.18	1000
AOI2520CN68N□T	68/50	G, J, K	65/350	1300	0.20	1000
AOI2520CN82N□T	82/50	G, J, K	60/350	1000	0.22	1000
AOI2520CNR10□T	100/25	G, J, K	60/350	1000	0.56	650
AOI2520CNR12□T	120/25	G, J, K	60/350	950	0.63	650
AOI2520CNR15□T	150/25	G, J, K	45/100	850	0.70	580
AOI2520CNR18□T	180/25	G, J, K	45/100	750	0.77	620
AOI2520CNR22□T	220/25	G, J, K	45/100	700	0.84	500
AOI2520CNR27□T	270/25	G, J, K	45/100	600	0.91	500
AOI2520CNR33□T	330/25	G, J, K	45/100	570	1.05	450
AOI2520CNR39□T	390/25	G, J, K	45/100	500	1.12	470
AOI2520CNR47□T	470/25	G, J, K	45/100	450	1.19	470
AOI2520CNR56□T	560/25	G, J, K	45/100	415	1.33	400
AOI2520CNR62□T	620/25	G, J, K	45/100	375	1.40	300
AOI2520CNR68□T	680/25	G, J, K	45/100	375	1.47	400
AOI2520CNR75□T	750/25	G, J, K	45/100	360	1.54	360
AOI2520CNR82□T	820/25	G, J, K	45/100	350	1.65	400
AOI2520CNR91□T	910/25	G, J, K	35/50	320	1.68	380
AOI2520CN1R0□T	1000/25	G, J, K	35/50	290	1.75	370
AOI2520CN1R2□T	1200/7.9	G, J, K	35/50	250	2.00	310
AOI2520CN1R5□T	1500/7.9	G, J, K	28/50	200	2.30	330
AOI2520CN1R8□T	1800/7.9	G, J, K	28/50	160	2.60	300
AOI2520CN2R2□T	2200/7.9	G, J, K	28/50	160	2.80	280
AOI2520CN2R7□T	2700/7.9	G, J, K	22/25	135	3.20	290
AOI2520CN3R3□T	3300/7.9	G, J, K	22/25	110	3.40	290
AOI2520CN3R9□T	3900/7.9	G, J, K	20/25	100	3.60	260
AOI2520CN4R7□T	4700/7.9	G, J, K	20/25	90	4.00	260
AOI2520CN5R6□T	5600/7.9	G, J, K	18/7.9	40	4.20	240
AOI2520CN6R8□T	6800/7.9	G, J, K	18/7.9	40	4.90	200
AOI2520CN8R2□T	8200/7.9	G, J, K	18/7.9	25	6.10	170
AOI2520CN100□T	10000/2.5	G, J, K	18/7.9	25	8.00	150

#### NOTE:

- The operating temperature range is -40°C to +125°C
- □ Tolerance G: ±2%, J: ±5%, K: ±10%
- Irms for 15°C rise above 25°C ambient.

## Specification

Part Number	Inductance (uH)/MHz	Inductance Tolerance	Q (Min.)/MHz	SRF(Min.) (MHz)	DCR (Ω) Max.	Idc (mA) Max.
<b>AOI2012FN Series Specification</b>						
AOI2012FNR12□T	0.12/25	J, K	25/25	1000	0.18	1500
AOI2012FNR15□T	0.15/25	J, K	25/25	1000	0.18	1400
AOI2012FNR18□T	0.18/25	J, K	30/25	1000	0.20	1400
AOI2012FNR22□T	0.22/25	J, K	30/25	830	0.25	1350
AOI2012FNR27□T	0.27/25	J, K	30/25	800	0.38	1300
AOI2012FNR33□T	0.33/25	J, K	30/25	750	0.35	1200
AOI2012FNR39□T	0.39/25	J, K	30/25	700	0.35	1160
AOI2012FNR47□T	0.47/25	J, K	30/25	690	0.40	1100
AOI2012FNR56□T	0.56/25	J, K	30/25	640	0.40	1040
AOI2012FNR62□T	0.62/25	J, K	30/25	640	0.45	980
AOI2012FNR68□T	0.68/25	J, K	30/25	510	0.50	900
AOI2012FNR82□T	0.82/25	J, K	30/25	500	0.50	900
AOI2012FNR91□T	0.91/25	J, K	30/25	500	0.55	900
AOI2012FN1R0□T	1.0/7.9	J, K	20/7.9	470	0.60	840
AOI2012FN1R2□T	1.2/7.9	J, K	20/7.9	400	0.75	800
AOI2012FN1R5□T	1.5/7.9	J, K	25/7.9	400	1.00	720
AOI2012FN1R8□T	1.8/7.9	J, K	25/7.9	230	1.00	660
AOI2012FN2R2□T	2.2/7.9	J, K	25/7.9	200	1.05	600
AOI2012FN2R7□T	2.7/7.9	J, K	25/7.9	130	1.18	500
AOI2012FN3R3□T	3.3/7.9	J, K	25/7.9	160	1.26	480
AOI2012FN3R9□T	3.9/7.9	J, K	25/7.9	130	1.75	440
AOI2012FN4R7□T	4.7/7.9	J, K	25/7.9	120	1.87	390
AOI2012FN5R6□T	5.6/7.9	J, K	25/7.9	90	2.00	340
AOI2012FN6R8□T	6.8/7.9	J, K	25/7.9	55	2.15	300
AOI2012FN8R2□T	8.2/7.9	J, K	25/7.9	40	2.37	280
AOI2012FN100□T	10/2.5	J, K	16/2.5	40	2.55	260
AOI2012FN120□T	12/2.5	J, K	16/2.5	37	2.80	220
AOI2012FN150□T	15/2.5	J, K	16/2.5	30	3.80	200
AOI2012FN180□T	18/2.5	J, K	16/2.5	23	4.48	180
AOI2012FN220□T	22/2.5	J, K	16/2.5	20	6.30	160
AOI2012FN270□T	27/2.5	J, K	16/2.5	19	6.85	140
AOI2012FN330□T	33/2.5	J, K	16/2.5	18	7.60	120
<b>AOI2520FN Series Specification</b>						
AOI2520FNR12□T	0.12/25	J, K	26/25	930	0.30	1000
AOI2520FNR18□T	0.18/25	J, K	30/25	930	0.30	960
AOI2520FNR20□T	0.20/25	J, K	30/25	735	0.30	960
AOI2520FNR22□T	0.22/25	J, K	27/25	750	0.40	880
AOI2520FNR33□T	0.33/25	J, K	30/25	600	0.42	900
AOI2520FNR39□T	0.39/25	J, K	30/25	480	0.45	920
AOI2520FNR47□T	0.47/25	J, K	30/25	470	0.50	920
AOI2520FNR56□T	0.56/25	J, K	30/25	460	0.55	900
AOI2520FNR62□T	0.62/25	J, K	30/25	460	0.55	900
AOI2520FNR68□T	0.68/25	J, K	30/25	420	0.55	880
AOI2520FNR75□T	0.75/25	J, K	30/25	420	0.65	880
AOI2520FNR82□T	0.82/25	J, K	30/25	380	0.65	840
AOI2520FNR91□T	0.91/25	J, K	30/25	400	0.65	840
AOI2520FN1R0□T	1.0/7.9	J, K	25/7.9	300	0.60	800
AOI2520FN1R2□T	1.2/7.9	J, K	25/7.9	280	0.74	800
AOI2520FN1R5□T	1.5/7.9	J, K	25/7.9	245	0.85	780
AOI2520FN1R8□T	1.8/7.9	J, K	25/7.9	240	0.92	780
AOI2520FN2R2□T	2.2/7.9	J, K	25/7.9	205	1.10	760
AOI2520FN2R7□T	2.7/7.9	J, K	25/7.9	187	1.22	760
AOI2520FN3R3□T	3.3/7.9	J, K	25/7.9	165	1.37	740
AOI2520FN3R9□T	3.9/7.9	J, K	25/7.9	144	1.66	700
AOI2520FN4R7□T	4.7/7.9	J, K	25/7.9	110	1.68	660

### NOTE:

- The operating temperature range is -25°C to +85°C    □ Tolerance J: ±5%, K: ±10%
- Idc for inductance drop 10% from its value without current.



## Specification

Part Number	Inductance (uH)/MHz	Inductance Tolerance	Q (Min.)/MHz	SRF(Min.) (MHz)	DCR (Ω) Max.	Idc (mA) Max.
<b>AOI2520FN Series Specification</b>						
AOI2520FN5R6□T	5.6/7.9	J, K	25/7.9	88	1.75	640
AOI2520FN6R8□T	6.8/7.9	J, K	25/7.9	70	1.85	640
AOI2520FN8R2□T	8.2/7.9	J, K	25/7.9	57	2.00	600
AOI2520FN100□T	10/7.9	J, K	25/7.9	55	2.32	600
AOI2520FN120□T	12/2.5	J, K	15/2.5	52	2.99	560
AOI2520FN150□T	15/2.5	J, K	15/2.5	49	3.42	480
AOI2520FN180□T	18/2.5	J, K	15/2.5	48	4.65	420
AOI2520FN220□T	22/2.5	J, K	15/2.5	25	5.12	420
AOI2520FN270□T	27/2.5	J, K	15/2.5	23	5.76	420
AOI2520FN330□T	33/2.5	J, K	15/2.5	17	6.44	400
AOI2520FN390□T	39/2.5	J, K	15/2.5	15	6.85	380
AOI2520FN470□T	47/2.5	J, K	14/2.5	13	9.94	260
AOI2520FN560□T	56/2.5	J, K	14/2.5	10	10.70	280
AOI2520FN680□T	68/2.5	J, K	14/2.5	8	12.80	260
AOI2520FN820□T	82/2.5	J, K	14/2.5	8	18.30	240
AOI2520FN101□T	100/1.0	J, K	8/1.0	7	19.60	200

### NOTE:

- The operating temperature range is -25°C to +85°C    □ Tolerance J: ±5%, K: ±10%
- Idc for inductance drop 10% from its value without current.

Part Number	Inductance (uH)/MHz	Inductance Tolerance	Q (Min.)/MHz	SRF(Typ.) (MHz)	DCR (Ω) Max.	Idc (mA) Max.
<b>AOI3225FN Series Specification</b>						
AOI3225FNR39□T	0.39/25	J	40/25	500	0.30	1500
AOI3225FNR82□T	0.82/25	J, K	35/25	340	0.38	1300
AOI3225FN1R0□T	1.0/7.9	J, K	35/7.9	320	0.42	1200
AOI3225FN1R2□T	1.2/7.9	J, K	35/7.9	280	0.47	1100
AOI3225FN1R5□T	1.5/7.9	J, K	35/7.9	250	0.50	1100
AOI3225FN1R8□T	1.8/7.9	J, K	40/7.9	203	0.62	1000
AOI3225FN2R2□T	2.2/7.9	J, K	33/7.9	200	0.65	1000
AOI3225FN2R7□T	2.7/7.9	J, K	40/7.9	200	0.65	1000
AOI3225FN3R0□T	3.0/7.9	J, K	40/7.9	180	0.78	800
AOI3225FN3R3□T	3.3/7.9	J, K	30/7.9	146	0.83	1200
AOI3225FN3R9□T	3.9/7.9	J, K	30/7.9	139	1.74	900
AOI3225FN4R7□T	4.7/7.9	J, K	35/7.9	124	1.90	800
AOI3225FN5R6□T	5.6/7.9	J, K	30/7.9	114	2.05	700
AOI3225FN6R8□T	6.8/7.9	J, K	30/7.9	109	1.37	450
AOI3225FN100□T	10/2.5	J, K	23/2.5	90	1.70	590
AOI3225FN150□T	15/2.5	J, K	25/2.5	67	2.22	340
AOI3225FN180□T	18/2.5	J, K	25/2.5	57	2.42	330
AOI3225FN220□T	22/2.5	J, K	25/2.5	48	2.66	300
AOI3225FN270□T	27/2.5	J, K	25/2.5	38	2.99	250
AOI3225FN330□T	33/2.5	J, K	25/2.5	26	3.24	220
AOI3225FN390□T	39/2.5	J, K	25/2.5	24	3.61	195
AOI3225FN470□T	47/2.5	J, K	25/2.5	22	3.96	195
AOI3225FN560□T	56/2.5	J, K	25/2.5	20	4.36	190
AOI3225FN680□T	68/2.5	J, K	23/2.5	15	4.50	340
AOI3225FN820□T	82/2.5	J, K	23/2.5	15	5.95	300
AOI3225FN101□T	100/1	J, K	15/1	14	6.62	250
AOI3225FN121□T	120/1	J, K	15/1	11	7.53	190
AOI3225FN151□T	150/1	J, K	15/1	11	8.29	135
AOI3225FN181□T	180/1	J, K	15/1	10	11.53	100
AOI3225FN221□T	220/1	J, K	15/1	8	12.48	80

### NOTE:

- The operating temperature range is -25°C to +85°C    □ Tolerance J: ±5%, K: ±10%
- Idc for inductance drop 10% from its value without current.

**Features**

- Utilizing a miniaturized winding structure.
- These products provide low DC resistance and high current.
- Precision inductance tolerance is available.

**Applications**

- Personal computers, Hard disk drives
- ADSL modem Cable modem
- Digital camera and other electronic equipment



**Shape & Dimensions**

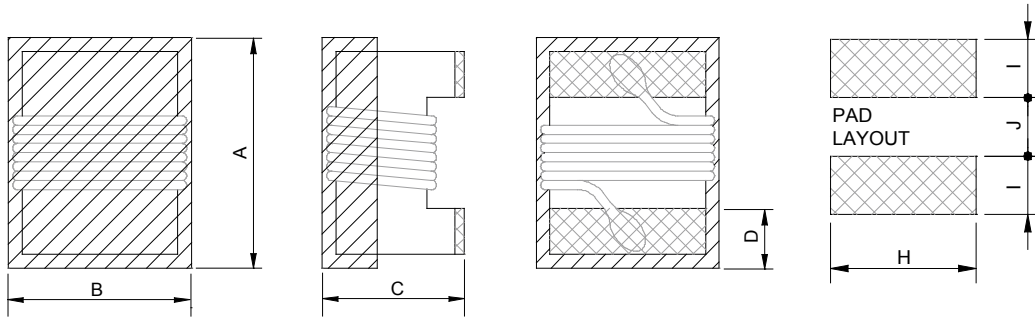

TYPE	A (mm)	B (mm)	C (mm)	D (mm)	H (Ref.)	I (Ref.)	J (Ref.)
AOIC1610N	1.8 MAX.	1.2 MAX.	1.1 MAX.	0.33±0.1	1.02	0.64	0.64
AOIC2012N	2.4 MAX.	1.65 MAX.	1.45 MAX.	0.44±0.1	1.78	1.02	0.76
AOIC2520N	2.9 MAX.	2.54 MAX.	2.03 MAX.	0.5±0.1	2.54	1.02	1.27
AOIC3225N	3.6 MAX.	2.9 MAX.	2.4 MAX.	0.5±0.1	2.70	1.20	2.00
AOIC1610D	1.8 MAX.	1.2 MAX.	1.0 MAX.	0.33	1.02	0.64	0.64
AOIC2012D	2.4 MAX.	1.65 MAX.	1.2±0.1	0.44±0.1	1.78	1.02	0.76

**Product Identification**

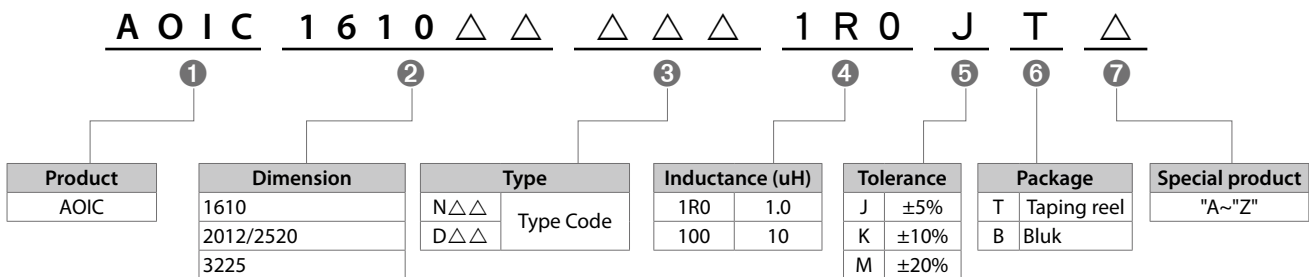

## Specification

Part Number	Inductance (uH)/MHz	Inductance Tolerance	Q (Min.)/MHz	SRF(Min.) (MHz)	DCR (Ω) Max.	Idc (mA) Max.
<b>AOIC1610N Series Specification</b>						
AOIC1610N47N□T	0.047/7.9	K	10/7.9	2000	0.075	1800
AOIC1610N51N□T	0.051/7.9	J	12/7.9	1500	0.075	1800
AOIC1610N68N□T	0.068/7.9	J	12/7.9	1500	0.120	1800
AOIC1610N72N□T	0.072/7.9	K	12/7.9	1500	0.120	1800
AOIC1610NR10□T	0.10/7.9	K	12/7.9	1150	0.13	1700
AOIC1610NR12□T	0.12/7.9	J, K	12/7.9	1100	0.15	1700
AOIC1610NR15□T	0.15/7.9	J, K	15/7.9	1050	0.15	1600
AOIC1610NR18□T	0.18/7.9	J, K	15/7.9	950	0.15	1500
AOIC1610NR22□T	0.22/7.9	J, K	15/7.9	900	0.30	1200
AOIC1610NR24□T	0.24/7.9	J, K	15/7.9	850	0.33	1200
AOIC1610NR27□T	0.27/7.9	J, K	15/7.9	835	0.35	1180
AOIC1610NR33□T	0.33/7.9	J, K	15/7.9	725	0.46	1000
AOIC1610NR39□T	0.39/7.9	J, K	15/7.9	680	0.41	1400
AOIC1610NR47□T	0.47/7.9	J, K	15/7.9	640	0.43	1400
AOIC1610NR56□T	0.56/7.9	J, K	15/7.9	630	0.44	1400
AOIC1610NR68□T	0.68/7.9	J, K	15/7.9	510	0.52	1340
AOIC1610NR78□T	0.78/7.9	J, K	15/7.9	465	0.63	1300
AOIC1610NR82□T	0.82/7.9	J, K	15/7.9	460	0.69	1200
AOIC1610N1R0□T	1.0/7.9	J, K	15/7.9	320	0.81	1100
AOIC1610N1R2□T	1.2/7.9	J, K	15/7.9	270	0.87	1000
AOIC1610N1R5□T	1.5/7.9	J, K	15/7.9	230	0.96	920
AOIC1610N1R8□T	1.8/7.9	J, K	15/7.9	210	1.10	900
AOIC1610N2R2□T	2.2/7.9	J, K	15/7.9	115	1.20	740
AOIC1610N2R7□T	2.7/7.9	J, K	15/7.9	100	1.38	700
AOIC1610N3R3□T	3.3/7.9	J, K	15/7.9	84	1.50	680
AOIC1610N3R9□T	3.9/7.9	J, K	15/7.9	75	1.50	600
AOIC1610N4R7□T	4.7/7.9	J, K	15/7.9	67	2.10	580
AOIC1610N5R6□T	5.6/7.9	J, K	15/7.9	55	2.37	540
AOIC1610N6R8□T	6.8/7.9	J, K	15/7.9	48	3.10	500
AOIC1610N7R8□T	7.8/7.9	J, K	15/7.9	40	3.35	460
AOIC1610N8R2□T	8.2/7.9	J, K	15/7.9	38	3.50	440
AOIC1610N100□T	10/7.9	J, K	15/7.9	32	4.46	400

### NOTE:

- The operating temperature range is -25°C to +85°C • □ Tolerance J:±5%, K: ±10%
- Idc for inductance drop 10% from its value without current.

Part Number	Inductance (uH)/MHz	Inductance Tolerance	Q (Typ.)/MHz	SRF(Min.) (MHz)	DCR (Ω) Max.	Idc (mA) Max.
<b>AOIC2012N Series Specification</b>						
AOIC2012NR56□T	0.56/25	J, K, M	10/25	550	0.13	1100
AOIC2012NR82□T	0.82/25	J, K, M	10/25	150	0.15	900
AOIC2012N1R0□T	1.0/7.9	J, K, M	18/7.9	100	0.23	800
AOIC2012N1R5□T	1.5/7.9	J, K, M	18/7.9	90	0.28	650
AOIC2012N1R8□T	1.8/7.9	J, K, M	22/7.9	210	0.45	550
AOIC2012N2R2□T	2.2/7.9	J, K, M	18/7.9	70	0.34	550
AOIC2012N3R3□T	3.3/7.9	J, K, M	18/7.9	55	0.44	450
AOIC2012N3R9□T	3.9/7.9	J, K, M	18/7.9	50	0.55	400
AOIC2012N4R7□T	4.7/7.9	J, K, M	18/7.9	50	0.65	360
AOIC2012N6R8□T	6.8/7.9	J, K, M	18/7.9	60	0.95	290
AOIC2012N100□T	10/2.5	J, K, M	18/2.5	25	1.10	290
AOIC2012N150□T	15/2.5	J, K, M	18/2.5	25	2.00	230
AOIC2012N180□T	18/2.5	J, K, M	18/2.5	20	2.20	210
AOIC2012N220□T	22/2.5	J, K, M	18/2.5	18	2.45	190
AOIC2012N330□T	33/2.5	J, K, M	17/2.5	15	3.04	120
AOIC2012N470□T	47/2.5	J, K, M	17/2.5	11	4.50	95
AOIC2012N680□T	68/2.5	J, K, M	17/2.5	11	6.80	95
AOIC2012N101□T	100/1.0	J, K, M	12/1.0	9	10.50	70

### NOTE:

- The operating temperature range is -25°C to +85°C • □ Tolerance J:±5%, K: ±10%, M: ±20%
- Idc for inductance drop 10% from its value without current.

## Specification

Part Number	Inductance (uH)/MHz	Inductance Tolerance	Q (Typ.)/MHz	SRF(Min.) (MHz)	DCR (Ω) Max.	Idc (mA) Max.
<b>AOIC2520N Series Specification</b>						
AOIC2520NR22□T	0.22/25	J, K	35/25	800	0.15	2600
AOIC2520NR47□T	0.47/25	K	35/25	460	0.20	2400
AOIC2520NR82□T	0.82/25	J, K	35/25	360	0.35	1800
AOIC2520N1R0□T	1.0/7.9	J, K	32/7.9	340	0.34	2100
AOIC2520N1R2□T	1.2/7.9	J, K	25/7.9	290	0.25	1900
AOIC2520N1R5□T	1.5/7.9	J, K	32/7.9	230	0.42	1500
AOIC2520N1R8□T	1.8/7.9	J, K	27/7.9	180	0.45	1500
AOIC2520N2R2□T	2.2/7.9	J, K	27/7.9	140	0.50	1200
AOIC2520N2R7□T	2.7/7.9	J, K	27/7.9	130	0.55	1300
AOIC2520N3R3□T	3.3/7.9	J, K	27/7.9	125	0.60	1300
AOIC2520N3R9□T	3.9/7.9	J, K	27/7.9	100	0.80	1200
AOIC2520N4R7□T	4.7/7.9	J, K	27/7.9	90	0.90	1100
AOIC2520N5R6□T	5.6/7.9	J, K	27/7.9	60	1.00	1000
AOIC2520N6R8□T	6.8/7.9	J, K	27/7.9	60	1.05	950
AOIC2520N8R2□T	8.2/7.9	J, K	25/7.9	55	1.20	850
AOIC2520N100□T	10/2.5	J, K	23/2.5	55	1.55	800
AOIC2520N120□T	12/2.5	J, K	23/2.5	36	2.10	630
AOIC2520N150□T	15/2.5	J, K	23/2.5	36	2.38	650
AOIC2520N180□T	18/2.5	J, K	23/2.5	32	2.50	550
AOIC2520N220□T	22/2.5	J, K	23/2.5	29	2.92	550
AOIC2520N330□T	33/2.5	J, K	23/2.5	21	4.10	450
AOIC2520N470□T	47/2.5	J, K	23/2.5	17	7.80	350
AOIC2520N101□T	100/1.0	J, K	13/1.0	4	13.20	200
AOIC2520N221□T	220/1.0	J, K	13/1.0	3	26.50	140
AOIC2520N331□T	330/1.0	J, K	13/1.0	2	32.50	110

### NOTE:

- The operating temperature range is -25°C to +85°C
- □ Tolerance J:±5%, K: ±10%
- Idc for inductance drop 10% from its value without current.

Part Number	Inductance (uH)/MHz	Inductance Tolerance	Q (Min.)/MHz	SRF(Min.) (MHz)	DCR (Ω) Max.	Idc (mA) Max.
<b>AOIC3225N Series Specification</b>						
AOIC3225NR39□T	0.39/25	J	40/25	500	0.090	3000
AOIC3225NR47□T	0.47/25	J, K	40/25	500	0.090	3000
AOIC3225NR56□T	0.56/25	K	40/25	500	0.100	3000
AOIC3225N1R0□T	1.0/7.9	J, K	35/7.9	340	0.125	2600
AOIC3225N1R2□T	1.2/7.9	K	35/7.9	280	0.135	2400
AOIC3225N1R5□T	1.5/7.9	K	30/7.9	160	0.145	2200
AOIC3225N1R8□T	1.8/7.9	J, K	30/7.9	120	0.160	2000
AOIC3225N2R2□T	2.2/7.9	J, K	30/7.9	100	0.170	1900
AOIC3225N2R5□T	2.5/7.9	J, K	30/7.9	80	0.190	1700
AOIC3225N3R3□T	3.3/7.9	J, K	30/7.9	70	0.210	1500
AOIC3225N4R7□T	4.7/7.9	J, K	28/7.9	55	0.30	1300
AOIC3225N6R8□T	6.8/7.9	J, K	28/7.9	45	0.370	1000
AOIC3225N8R2□T	8.2/7.9	J, K	28/7.9	45	0.470	940
AOIC3225N100□T	10/2.5	J, K	22/2.5	47	0.500	900
AOIC3225N120□T	12/2.5	J, K	22/2.5	42	0.680	770
AOIC3225N150□T	15/2.5	J, K	22/2.5	34	0.720	740
AOIC3225N180□T	18/2.5	J, K	22/2.5	28	0.950	630
AOIC3225N220□T	22/2.5	J, K	22/2.5	25	1.100	600
AOIC3225N270□T	27/2.5	J, K	20/2.5	18	1.250	520
AOIC3225N330□T	33/2.5	J, K	20/2.5	13	1.370	490
AOIC3225N470□T	47/2.5	J, K	20/2.5	12	1.880	400
AOIC3225N560□T	56/2.5	J, K	22/2.5	10	2.750	360
AOIC3225N680□T	68/2.5	J, K	22/2.5	10	3.00	340
AOIC3225N820□T	82/2.5	J, K	22/2.5	10	4.10	300
AOIC3225N101□T	100/1.0	J, K	15/1.0	8	4.682	270
AOIC3225N121□T	120/1.0	J, K	15/1.0	7	5.800	220
AOIC3225N151□T	150/1.0	J, K	13/1.0	7	6.102	220
AOIC3225N181□T	180/1.0	J, K	13/1.0	3	7.10	200
AOIC3225N221□T	220/1.0	J, K	13/1.0	3	7.650	180
AOIC3225N331□T	330/1.0	J, K	13/1.0	3	12.620	160
AOIC3225N471□T	470/1.0	J, K	13/1.0	3	25.00	120
AOIC3225N561□T	560/1.0	J, K	13/1.0	2	27.00	100
AOIC3225N681□T	680/1.0	J, K	13/1.0	2	31.00	100
AOIC3225N821□T	820/1.0	J, K	10/1.0	2	42.00	50
AOIC3225N102□T	1000/1.0	J, K	10/1.0	2	46.00	50

### NOTE:

- The operating temperature range is -25°C to +85°C
- □ Tolerance J:±5%, K: ±10%
- Idc for inductance drop 10% from its value without current.

### Specification

Part Number	Inductance (uH)/MHz	Inductance Tolerance	Q (Typ.)/MHz	SRF(Typ.) (MHz)	DCR (Ω) ±30%	Idc (mA) Typ.	Irms (mA) Typ.
<b>AOIC1610D Series Specification</b>							
AOIC1610D1R0□T	1.0/7.9	K, M	16/7.9	390	0.32	860	700
AOIC1610D1R5□T	1.5/7.9	K, M	16/7.9	160	0.40	720	600
AOIC1610D1R8□T	1.8/7.9	K, M	16/7.9	121	0.43	640	580
AOIC1610D2R2□T	2.2/7.9	K, M	16/7.9	103	0.56	600	580
AOIC1610D2R7□T	2.7/7.9	K, M	16/7.9	72	0.62	540	500
AOIC1610D3R3□T	3.3/7.9	K, M	16/7.9	66	0.70	500	500
AOIC1610D3R9□T	3.9/7.9	K, M	16/7.9	61	0.83	460	460
AOIC1610D4R7□T	4.7/7.9	K, M	16/7.9	51	0.97	400	420
AOIC1610D5R6□T	5.6/7.9	K, M	16/7.9	47	1.10	380	380
AOIC1610D6R8□T	6.8/7.9	K, M	16/7.9	43	1.50	340	340
AOIC1610D8R2□T	8.2/7.9	K, M	16/7.9	40	1.68	300	300
AOIC1610D100□T	10/2.5	K, M	14/2.5	36	1.85	280	280
AOIC1610D120□T	12/2.5	K, M	14/2.5	32	2.28	260	260
AOIC1610D150□T	15/2.5	K, M	14/2.5	29	2.60	240	240
AOIC1610D180□T	18/2.5	K, M	14/2.5	28	2.90	220	220
AOIC1610D220□T	22/2.5	K, M	14/2.5	24	3.61	200	200
AOIC1610D270□T	27/2.5	K, M	14/2.5	20	5.20	140	140
AOIC1610D330□T	33/2.5	K, M	14/2.5	15	6.60	120	120

#### NOTE:

- The operating temperature range is -25°C to +85°C    • □ Tolerance K: ±10%, M: ±20%
- Idc for inductance drop 10% from its value without current.
- Irms for 15°C rise above 25°C ambient.

Part Number	Inductance (uH)/MHz	Inductance Tolerance	Q (Typ.)/MHz	SRF(Typ.) (MHz)	DCR (Ω) ±30%	Idc (mA) Typ.	Irms (mA) Typ.
<b>AOIC2012D Series Specification</b>							
AOIC2012D1R0□T	1.0/7.9	K, M	14/7.9	208	0.13	1100	1300
AOIC2012D1R2□T	1.2/7.9	K, M	14/7.9	159	0.16	960	1270
AOIC2012D1R5□T	1.5/7.9	K, M	14/7.9	159	0.17	920	1260
AOIC2012D1R8□T	1.8/7.9	K, M	14/7.9	112	0.20	860	1080
AOIC2012D2R2□T	2.2/7.9	K, M	13/7.9	87	0.22	740	1040
AOIC2012D2R7□T	2.7/7.9	K, M	13/7.9	72	0.25	680	1040
AOIC2012D3R3□T	3.3/7.9	K, M	12/7.9	70	0.28	620	1020
AOIC2012D3R9□T	3.9/7.9	K, M	14/7.9	61	0.38	580	960
AOIC2012D4R7□T	4.7/7.9	K, M	14/7.9	51	0.43	520	840
AOIC2012D5R6□T	5.6/7.9	K, M	12/7.9	47	0.50	480	800
AOIC2012D6R8□T	6.8/7.9	K, M	14/7.9	46	0.68	420	700
AOIC2012D8R2□T	8.2/7.9	K, M	13/7.9	33	0.73	400	680
AOIC2012D100□T	10/2.5	J, K, M	14/2.5	31	0.85	360	560
AOIC2012D120□T	12/2.5	J, K, M	14/2.5	30	0.90	340	460
AOIC2012D150□T	15/2.5	J, K, M	15/2.5	28	1.40	300	380
AOIC2012D180□T	18/2.5	J, K, M	15/2.5	27	1.55	280	360
AOIC2012D220□T	22/2.5	J, K, M	15/2.5	20	1.76	240	340
AOIC2012D270□T	27/2.5	J, K, M	15/2.5	17	2.00	220	300
AOIC2012D330□T	33/2.5	J, K, M	15/2.5	17	2.35	200	300
AOIC2012D470□T	47/2.5	J, K, M	14/2.5	15	3.40	160	280
AOIC2012D560□T	56/2.5	J, K, M	14/2.5	10	4.42	150	240
AOIC2012D680□T	68/2.5	J, K, M	14/2.5	10	4.45	140	240
AOIC2012D820□T	82/2.5	J, K, M	14/2.5	10	7.50	100	180
AOIC2012D101□T	100/1.0	J, K, M	10/1.0	9	7.50	100	180

#### NOTE:

- The operating temperature range is -25°C to +85°C    • □ Tolerance J: ±5%, K: ±10%, M: ±20%
- Idc for inductance drop 10% from its value without current.
- Irms for 15°C rise above 25°C ambient.

**Features**

- Suitable for flow and reflow soldering.
- Excellent solderability and heat resistance.

**Applications**

Noise elimination for I/O lines of notebook PCs, digital TVs and VTRs, Printers, hard disk drives. Personal computers and general consumer and computers products.



**Shape & Dimensions**

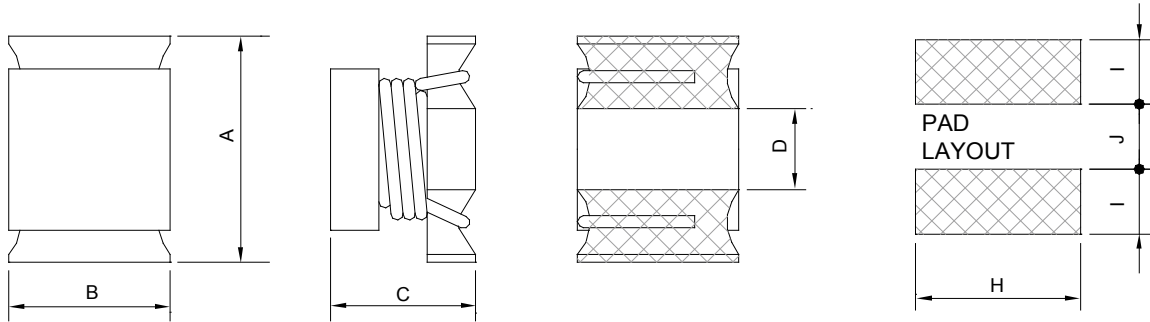

TYPE	A (mm)	B (mm)	C (mm)	D (mm)	H (Ref.)	I (Ref.)	J (Ref.)
AQH2520	2.5±0.3	2.0±0.2	1.8±0.4	1.3 Ref.	2.8	1.00	1.0
AQH3225	3.2±0.3	2.5±0.2	2.0±0.4	1.1 Ref.	3.4	1.45	1.5
AQH4532	4.5±0.3	3.2±0.2	2.6±0.4	1.6 Ref.	4.2	2.10	1.7

**Product Identification**

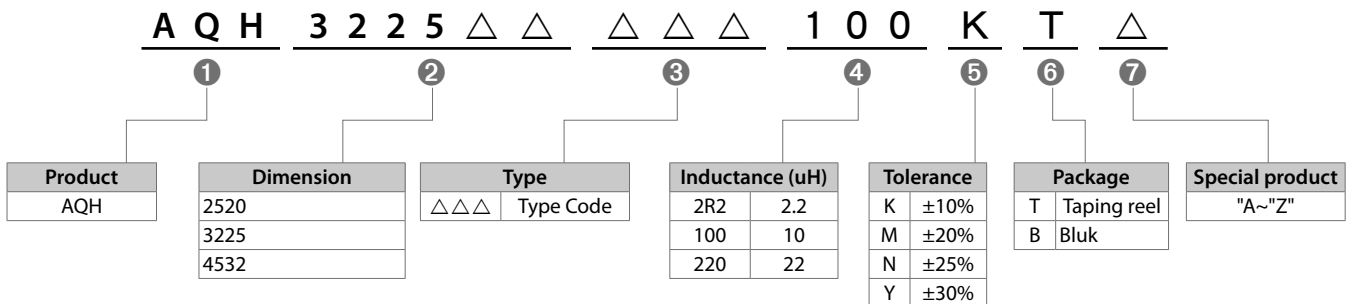



### Specification

Part Number	Inductance (H)	Test Freq. (MHz)	SRF (MHz)	DCR (Ω) Max.	Rated Current (mA) Max.
<b>AQH2520 Series Specification</b>					
AQH25201R0□T	1.0u	1.0	100.0	0.078	300
AQH25201R2□T	1.2u	1.0	100.0	0.09	290
AQH25201R5□T	1.5u	1.0	75.0	0.10	280
AQH25201R8□T	1.8u	1.0	60.0	0.11	270
AQH25202R2□T	2.2u	1.0	50.0	0.12	250
AQH25202R7□T	2.7u	1.0	43.0	0.20	240
AQH25203R3□T	3.3u	1.0	38.0	0.24	230
AQH25203R9□T	3.9u	1.0	35.0	0.28	220
AQH25204R7□T	4.7u	1.0	31.0	0.30	210
AQH25205R6□T	5.6u	1.0	28.0	0.34	205
AQH25206R8□T	6.8u	1.0	25.0	0.44	200
AQH25208R2□T	8.2u	1.0	23.0	0.59	195
AQH2520100□T	10u	1.0	20.0	0.68	190
AQH2520120□T	12u	1.0	18.0	0.77	185
AQH2520150□T	15u	1.0	16.0	0.87	180
AQH2520180□T	18u	1.0	15.0	1.20	175
AQH2520220□T	22u	1.0	14.0	1.34	170
AQH2520270□T	27u	1.0	13.0	1.86	165
AQH2520330□T	33u	1.0	12.0	2.10	160
AQH2520390□T	39u	1.0	11.0	2.35	155
AQH2520470□T	47u	1.0	11.0	3.30	150
AQH2520560□T	56u	1.0	10.0	3.70	145
AQH2520680□T	68u	1.0	9.0	6.00	135
AQH2520820□T	82u	1.0	8.0	6.90	125
AQH2520101□T	100u	1.0	9.0	7.75	110
<b>AQH3225 Series Specification</b>					
AQH3225R10□T	0.1u	1.0	200.0	0.25	700
AQH3225R18□T	0.18u	1.0	200.0	0.25	650
AQH3225R27□T	0.27u	1.0	200.0	0.25	600
AQH3225R39□T	0.39u	1.0	200.0	0.25	530
AQH3225R56□T	0.56u	1.0	160.0	0.25	530
AQH3225R68□T	0.68u	1.0	160.0	0.25	470
AQH3225R82□T	0.82u	1.0	120.0	0.25	450
AQH32251R0□T	1.0u	1.0	100.0	0.50	445
AQH32251R2□T	1.2u	1.0	100.0	0.60	425
AQH32251R5□T	1.5u	1.0	75.0	0.60	400
AQH32251R8□T	1.8u	1.0	60.0	0.70	390
AQH32252R2□T	2.2u	1.0	50.0	0.80	370
AQH32252R7□T	2.7u	1.0	43.0	0.90	320
AQH32253R3□T	3.3u	1.0	38.0	1.00	300
AQH32253R9□T	3.9u	1.0	35.0	1.10	290
AQH32254R7□T	4.7u	1.0	31.0	1.20	270
AQH32255R6□T	5.6u	1.0	28.0	1.30	250
AQH32256R8□T	6.8u	1.0	25.0	1.50	240
AQH32258R2□T	8.2u	1.0	23.0	1.60	225
AQH3225100□T	10u	1.0	20.0	1.80	190
AQH3225120□T	12u	1.0	18.0	2.00	180
AQH3225150□T	15u	1.0	16.0	2.20	170
AQH3225180□T	18u	1.0	15.0	2.50	165
AQH3225220□T	22u	1.0	14.0	2.80	150
AQH3225270□T	27u	1.0	13.0	3.10	125
AQH3225330□T	33u	1.0	12.0	3.50	115

**NOTE:**

- The operating temperature range is -25°C to +85°C
- □ Tolerance K: ±10%, M: ±20%

### Specification

Part Number	Inductance (H)	Test Freq. (MHz)	SRF (MHz)	DCR (Ω) Max.	Rated Current (mA) Max.
<b>AQH4532 Series Specification</b>					
AQH45321R0□T	1.0u	1.0	120.0	0.20	500
AQH45321R2□T	1.2u	1.0	100.0	0.20	500
AQH45321R5□T	1.5u	1.0	85.0	0.30	500
AQH45321R8□T	1.8u	1.0	75.0	0.30	500
AQH45322R2□T	2.2u	1.0	62.0	0.30	500
AQH45322R7□T	2.7u	1.0	53.0	0.32	500
AQH45323R3□T	3.3u	1.0	47.0	0.35	500
AQH45323R9□T	3.9u	1.0	41.0	0.38	500
AQH45324R7□T	4.7u	1.0	38.0	0.40	500
AQH45325R6□T	5.6u	1.0	33.0	0.47	500
AQH45326R8□T	6.8u	1.0	31.0	0.50	450
AQH45328R2□T	8.2u	1.0	27.0	0.56	450
AQH4532100□T	10u	1.0	23.0	0.56	400
AQH4532120□T	12u	1.0	21.0	0.62	380
AQH4532150□T	15u	1.0	19.0	0.73	360
AQH4532180□T	18u	1.0	17.0	0.82	340
AQH4532220□T	22u	1.0	15.0	0.94	320
AQH4532270□T	27u	1.0	14.0	1.10	300
AQH4532330□T	33u	1.0	12.0	1.20	270
AQH4532390□T	39u	1.0	11.0	1.40	240
AQH4532470□T	47u	1.0	10.0	1.50	220
AQH4532560□T	56u	1.0	9.3	1.70	200
AQH4532680□T	68u	1.0	8.4	1.90	180
AQH4532820□T	82u	1.0	7.5	2.20	170
AQH4532101□T	100u	1.0	6.8	2.50	160
AQH4532121□T	120u	1.0	6.2	3.00	150
AQH4532151□T	150u	1.0	5.5	3.70	130
AQH4532181□T	180u	1.0	5.0	4.50	120
AQH4532221□T	220u	1.0	4.5	5.40	110
AQH4532271□T	270u	1.0	4.0	6.80	100
AQH4532331□T	330u	1.0	3.6	8.20	95
AQH4532391□T	390u	1.0	3.3	9.70	90
AQH4532471□T	470u	1(KHz)	3.0	11.80	80
AQH4532561□T	560u	1(KHz)	2.7	14.50	70
AQH4532681□T	680u	1(KHz)	2.5	17.00	65
AQH4532821□T	820u	1(KHz)	2.2	20.50	60
AQH4532102□T	1000u	1(KHz)	2.0	25.00	50
AQH4532122□T	1200u	1(KHz)	1.8	30.00	45
AQH4532152□T	1500u	1(KHz)	1.6	37.00	40
AQH4532182□T	1800u	1(KHz)	1.5	45.00	35
AQH4532222□T	2200u	1(KHz)	1.3	50.00	30

**NOTE:**

- The operating temperature range is -25°C to +85°C
- □ Tolerance K: ±10%, M: ±20%

# EMI SUPPRESSION FILTER

## Features

- This common mode filter is characterized by its small sized
- Highly effective in noise suppression. High common-mode impedance at noise band and low differential-mode impedance at signal band.
- Due to the low differential-mode impedance with High coupling factor, there is almost no distortion on high speed signal.
- This series is micro-produced by auto machines for its huge productivity and accuracy with all-day CCD inspection

## Applications

Used for noise suppression in any electronic devices such as personal computer and peripheral equipment (USB), amusement equipment (IEEE1394), LCD panels (LVDS) etc.



## Shape & Dimensions

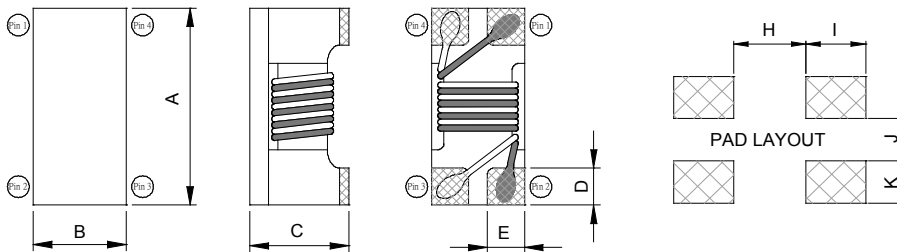

TYPE	A (mm)	B (mm)	C (mm)	D (mm)	E (mm)	H (Ref.)	I (Ref.)	J (Ref.)	K (Ref.)
ATCM2012	2.0±0.2	1.2±0.2	1.2±0.2	0.45 Typ.	0.4 Typ.	0.8	0.9	0.4	0.4
ATCM3216	3.2±0.2	1.6±0.2	1.8±0.2	0.45 Typ.	0.45 Typ.	1.6	1.1	0.4	0.6

## Product Identification

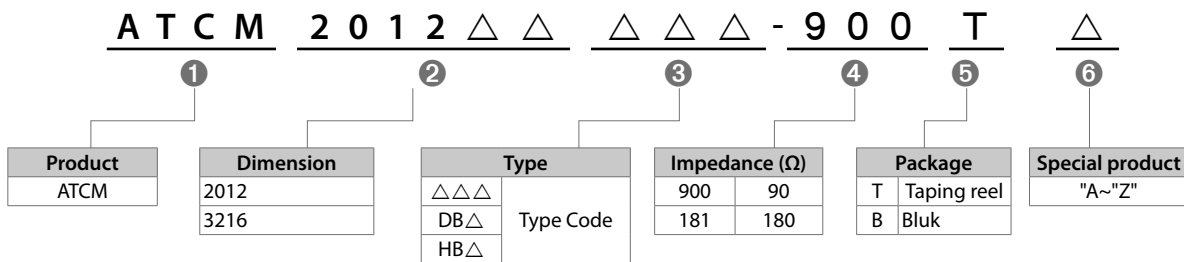

## Specification

Part Number	Common-Mode Impedance (Ω)	Test Freq. (MHz)	DCR Max. (Ω)	Rated Current (mA) Max.	Rated Voltage (V)	Withstanding Voltage (V)	Insulation Resistance (MΩ) Min.
<b>ATCM Series Specification</b>							
ATCM2012-670T	67	100	0.25	400	50	125	10
ATCM2012-900T	90	100	0.35	400	50	125	10
ATCM2012-121T	120	100	0.30	370	50	125	10
ATCM2012-181T	180	100	0.35	330	50	125	10
ATCM2012-201T	200	100	0.35	330	50	125	10
ATCM2012-261T	260	100	0.40	300	50	125	10
ATCM2012-371T	370	100	0.40	280	50	125	10
ATCM3216-900T	90	100	0.30	370	50	125	10
ATCM3216-161T	160	100	0.40	340	50	125	10
ATCM3216-261T	260	100	0.50	310	50	125	10
ATCM3216-601T	600	100	0.80	260	50	125	10
ATCM3216-102T	1000	100	1.00	230	50	125	10
ATCM3216-222T	2200	100	1.20	200	50	125	10

**NOTE:**

- The operating temperature range is -40°C to +85°C
- Tolerance : ±25%

## Typical Impedance v.s. Frequency Curve

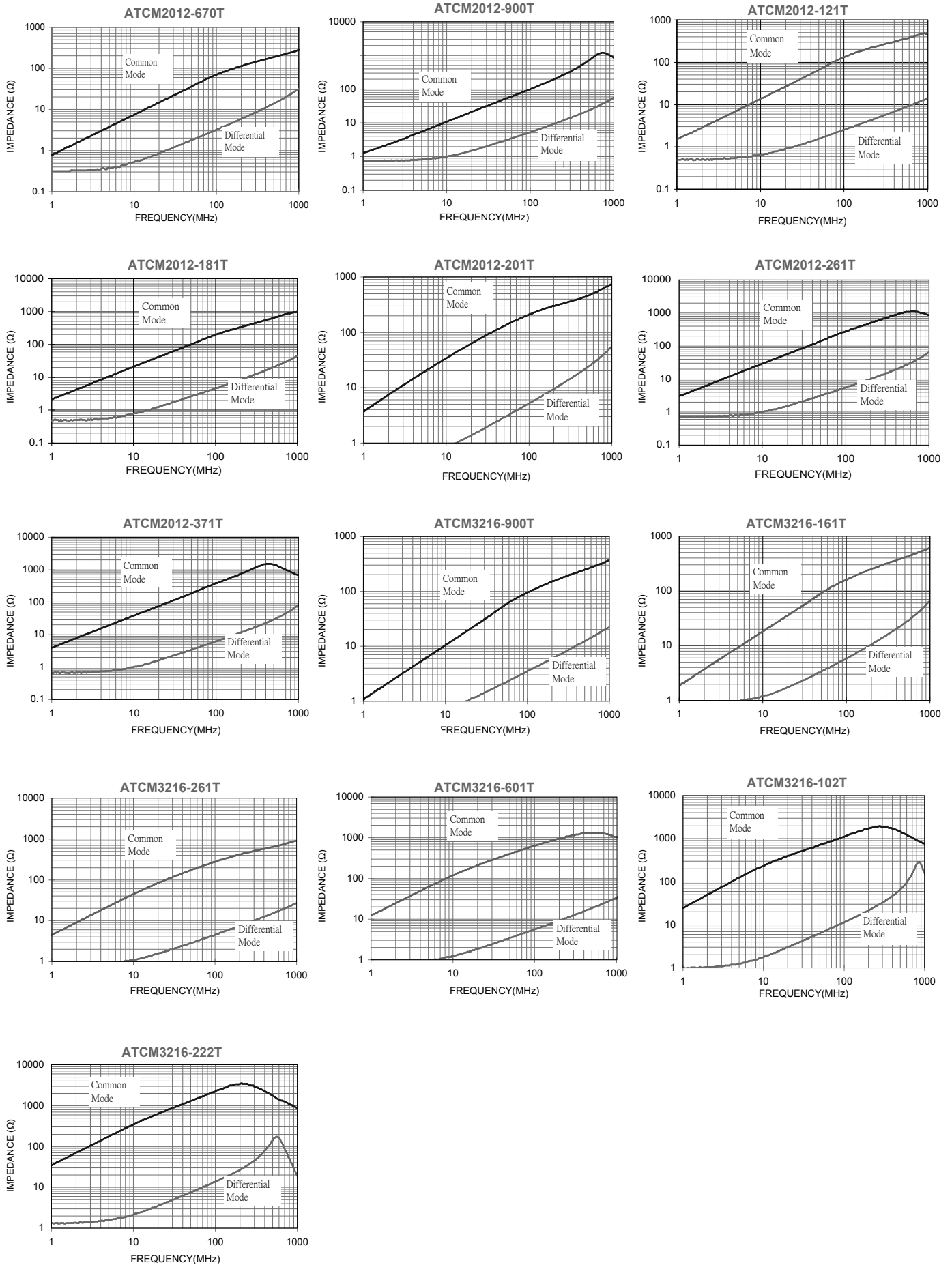

# EMI SUPPRESSION FILTER

## Features

- These are a series of broadband common mode filters developed for high-speed differential signal interface, such as DVI and HDMI.
- The cutoff frequencies in differential mode for ATCM2012DB and ATCM2012HB are 3.5 GHz and 6.0GHz respectively, so it doesn't interfere with high-speed differential signals.
- The characteristic impedance is approximated to 100Ω conforming to the TDR standard for HDMI.

## Applications

- For new HDMI interfaces used in digital video devices:  
 ATCM2012HB is suited for use on the transmission side (Source) of digital TVs, DVD recorders and liquid crystal projectors.  
 ATCM2012DB is suited for use on the receiving side (Sink).
- For digital video signal interfaces DVI (UXGA) used in PCs and other devices/High-speed differential signal interfaces for USB
- 0, IEEE 1394 and Serial-ATA.



## Shape & Dimensions

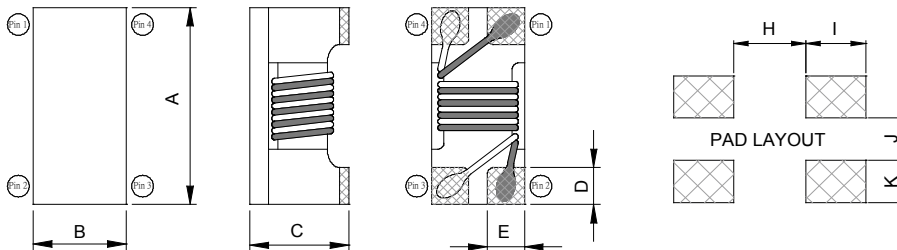

TYPE	A (mm)	B (mm)	C (mm)	D (mm)	E (mm)	H (Ref.)	I (Ref.)	J (Ref.)	K (Ref.)
ATCM2012DB	2.0±0.2	1.2±0.2	1.2±0.2	0.45 Typ.	0.4	0.8	0.9	0.4	0.4
ATCM2012HB	2.0±0.2	1.2±0.2	1.2±0.2	0.45 Typ.	0.4	0.8	0.9	0.4	0.4

## Product Identification

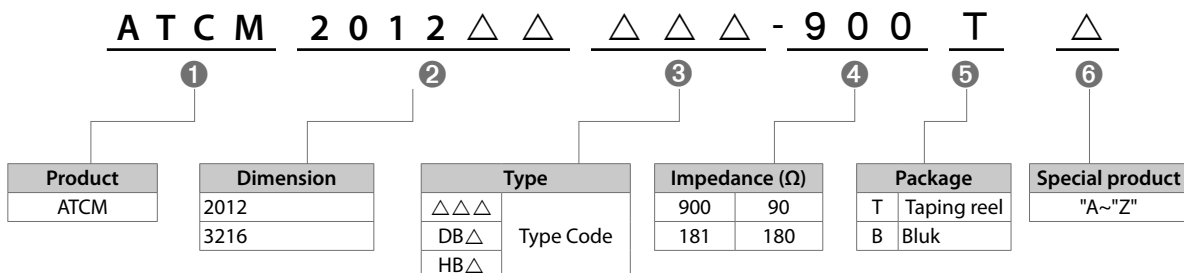

### Specification

Part Number	Common-Mode Impedance ( $\Omega$ )	Test Freq. (MHz)	DCR Max. ( $\Omega$ )	Rated Current (mA) Max.	Rated Voltage (V)	Cut-off Frequency (GHz)	Insulation Resistance ( $M\Omega$ ) Min.
<b>ATCM2012DB Series Specification</b>							
ATCM2012DB-900T	90 $\pm$ 25%	100	0.30	300	20	3.5 typ.	10
<b>ATCM2012HB Series Specification</b>							
ATCM2012HB-900T	65 Min. (90 typ.)	100	0.30	300	20	6.0 typ.	10

#### NOTE:

- The operating temperature range is -40°C to +85°C
- Tolerance:  $\pm$ 25%

#### Typical Impedance v.s. Frequency Curve

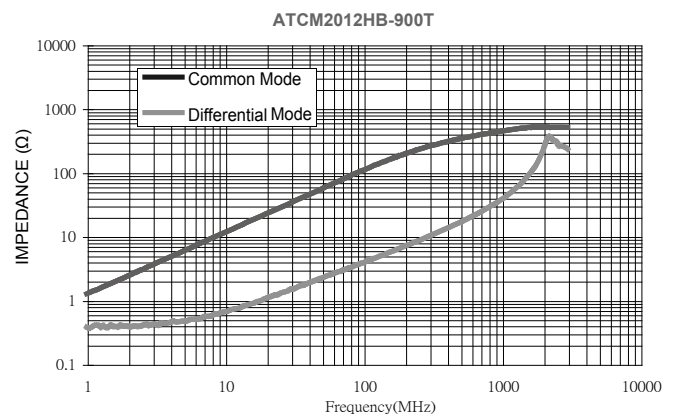
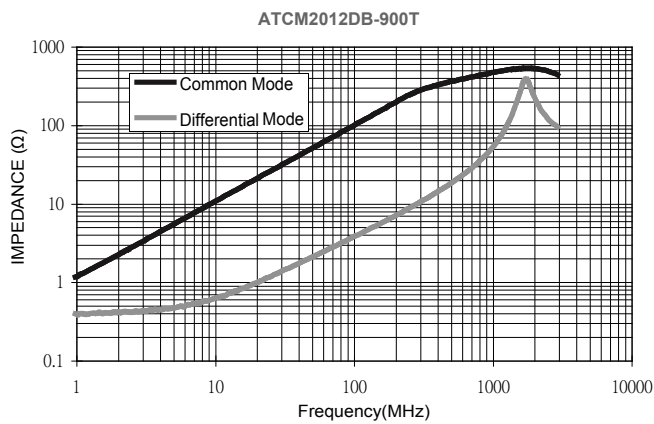



**Features**

- Leaching resistant terminations due to metal tab. electrodes.
- Coils encapsulated in heat-proof resin make high accurate dimensions and resistant to mechanical shock or pressure.
- High resistance to heat and humidity.

**Applications**

Micro televisions, liquid crystal television, video camera, portable VCRs, car radios, car stereos, thin type radio, television tuners, mobile telephones, radio equipment, modules such as hybrid ICs.



**Shape & Dimensions**

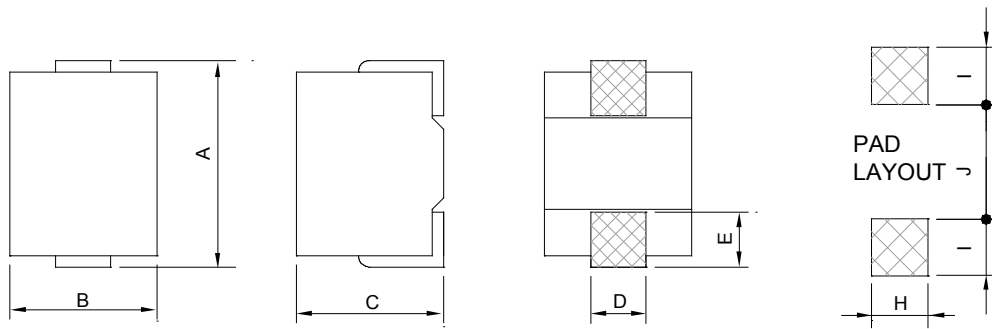

TYPE	A (mm)	B (mm)	C (mm)	D (mm)	E (mm)	H (Ref.)	I (Ref.)	J (Ref.)
AWI2520	2.5±0.2	2.0±0.2	1.8±0.2	1.4 Ref.	0.4 Ref.	1.5	1.0	1.5
AWI3225	3.2±0.4	2.5±0.2	2.2±0.2	1.1 Ref.	0.6 Ref.	2.0	1.0	1.8
AWI4532	4.5±0.3	3.2±0.2	3.2±0.2	1.3 Ref.	1.2 Ref.	2.5	1.5	3.0

**Product Identification**

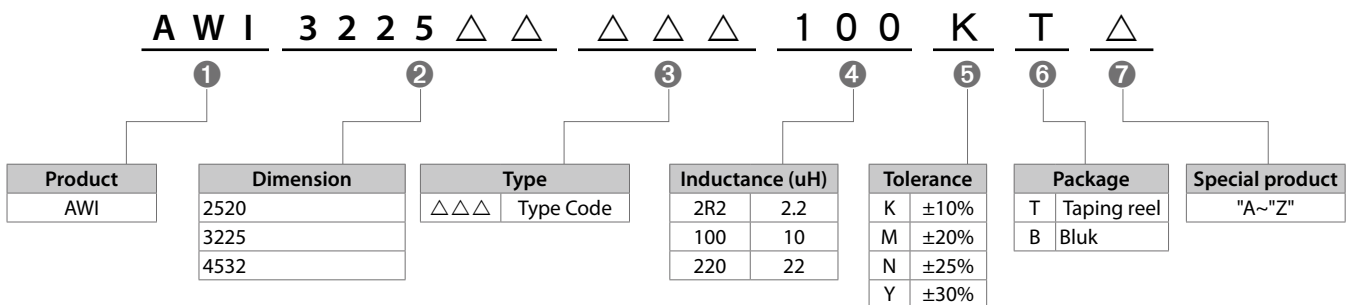

### Specification

Part Number	Inductance (H)	Q Min.	Test Freq. (MHz)	SRF (MHz)	DCR (Ω) Max.	Rated Current (mA) Max.
<b>AWI2520 Series Specification</b>						
AWI2520-R10□T	0.10u	20	100	800	0.80	280
AWI2520-R12□T	0.12u	30	25.2	700	0.30	550
AWI2520-R15□T	0.15u	30	25.2	550	0.35	500
AWI2520-R18□T	0.18u	30	25.2	500	0.40	460
AWI2520-R22□T	0.22u	30	25.2	450	0.50	430
AWI2520-R27□T	0.27u	30	25.2	425	0.55	420
AWI2520-R33□T	0.33u	30	25.2	400	0.60	400
AWI2520-R39□T	0.39u	30	25.2	375	0.65	375
AWI2520-R47□T	0.47u	30	25.2	350	0.68	350
AWI2520-R56□T	0.56u	30	25.2	325	0.75	325
AWI2520-R68□T	0.68u	30	25.2	300	0.85	300
AWI2520-R82□T	0.82u	30	25.2	260	1.00	260
AWI2520-1R0□T	1.0u	30	7.96	245	1.10	245
AWI2520-1R2□T	1.2u	30	7.96	230	1.20	230
AWI2520-1R5□T	1.5u	30	7.96	182	1.30	220
AWI2520-1R8□T	1.8u	30	7.96	135	1.45	210
AWI2520-2R2□T	2.2u	30	7.96	105	1.55	200
AWI2520-2R7□T	2.7u	30	7.96	70	1.70	195
AWI2520-3R3□T	3.3u	30	7.96	55	1.90	185
AWI2520-3R9□T	3.9u	30	7.96	48	2.10	180
AWI2520-4R7□T	4.7u	30	7.96	43	2.30	175
AWI2520-5R6□T	5.6u	25	7.96	42	2.50	170
AWI2520-6R8□T	6.8u	25	7.96	39	2.70	165
AWI2520-8R2□T	8.2u	25	7.96	36	3.05	160
AWI2520-100□T	10u	25	2.52	33	3.50	155
AWI2520-120□T	12u	25	2.52	30	3.80	150
AWI2520-150□T	15u	25	2.52	26	4.40	140
<b>AWI3225 Series Specification</b>						
AWI3225-R12□T	0.12u	30	25.2	500	0.22	450
AWI3225-R15□T	0.15u	30	25.2	450	0.25	450
AWI3225-R18□T	0.18u	30	25.2	400	0.28	450
AWI3225-R22□T	0.22u	30	25.2	350	0.32	450
AWI3225-R27□T	0.27u	30	25.2	320	0.36	450
AWI3225-R33□T	0.33u	30	25.2	300	0.40	450
AWI3225-R39□T	0.39u	30	25.2	250	0.45	450
AWI3225-R47□T	0.47u	30	25.2	220	0.50	450
AWI3225-R56□T	0.56u	30	25.2	180	0.55	450
AWI3225-R68□T	0.68u	30	25.2	160	0.60	450
AWI3225-R82□T	0.82u	30	25.2	140	0.65	450
AWI3225-1R0□T	1.0u	30	7.96	120	0.70	400
AWI3225-1R2□T	1.2u	30	7.96	100	0.75	390
AWI3225-1R5□T	1.5u	30	7.96	85	0.85	370
AWI3225-1R8□T	1.8u	30	7.96	80	0.90	350
AWI3225-2R2□T	2.2u	30	7.96	75	1.00	320
AWI3225-2R7□T	2.7u	30	7.96	70	1.10	290
AWI3225-3R3□T	3.3u	30	7.96	60	1.20	260
AWI3225-3R9□T	3.9u	30	7.96	55	1.30	250
AWI3225-4R7□T	4.7u	30	7.96	50	1.50	220
AWI3225-5R6□T	5.6u	30	7.96	47	1.60	200
AWI3225-6R8□T	6.8u	30	7.96	43	1.80	180
AWI3225-8R2□T	8.2u	30	7.96	40	2.00	170

#### NOTE:

- The operating temperature range is -40°C to +85°C
- □ Tolerance K: ±10%, M: ±20%

## Specification

Part Number	Inductance (H)	Q Min.	Test Freq. (MHz)	SRF (MHz)	DCR (Ω) Max.	Rated Current (mA) Max.
<b>AWI3225 Series Specification</b>						
AWI3225-100□T	10u	30	2.52	36	2.10	150
AWI3225-120□T	12u	30	2.52	33	2.50	140
AWI3225-150□T	15u	30	2.52	28	2.80	130
AWI3225-180□T	18u	30	2.52	25	3.30	120
AWI3225-220□T	22u	30	2.52	23	3.70	110
AWI3225-270□T	27u	30	2.52	18	5.00	80
AWI3225-330□T	33u	30	2.52	17	5.60	70
AWI3225-390□T	39u	30	2.52	16	6.40	65
AWI3225-470□T	47u	30	2.52	15	7.00	60
AWI3225-560□T	56u	30	2.52	13	8.00	55
AWI3225-680□T	68u	30	2.52	12	9.00	50
AWI3225-820□T	82u	30	2.52	11	10	45
AWI3225-101□T	100u	20	0.796	10	12	40
AWI3225-121□T	120u	20	0.796	10	12	70
AWI3225-151□T	150u	20	0.796	8	15	65
AWI3225-181□T	180u	20	0.796	7	17	60
AWI3225-221□T	220u	20	0.796	7	21	50
<b>AWI4532 Series Specification</b>						
AWI4532-R10□T	0.10u	35	25.2	300	0.18	800
AWI4532-R12□T	0.12u	35	25.2	280	0.20	770
AWI4532-R15□T	0.15u	35	25.2	250	0.22	730
AWI4532-R18□T	0.18u	35	25.2	220	0.24	700
AWI4532-R22□T	0.22u	40	25.2	200	0.25	665
AWI4532-R27□T	0.27u	40	25.2	180	0.26	635
AWI4532-R33□T	0.33u	40	25.2	165	0.28	605
AWI4532-R39□T	0.39u	40	25.2	150	0.30	575
AWI4532-R47□T	0.47u	40	25.2	145	0.32	545
AWI4532-R56□T	0.56u	40	25.2	140	0.36	520
AWI4532-R68□T	0.68u	40	25.2	135	0.40	500
AWI4532-R82□T	0.82u	40	25.2	130	0.45	475
AWI4532-1R0□T	1.0u	50	7.96	100	0.50	450
AWI4532-1R2□T	1.2u	50	7.96	80	0.55	430
AWI4532-1R5□T	1.5u	50	7.96	70	0.60	410
AWI4532-1R8□T	1.8u	50	7.96	60	0.65	390
AWI4532-2R2□T	2.2u	50	7.96	55	0.70	380
AWI4532-2R7□T	2.7u	50	7.96	50	0.75	370
AWI4532-3R3□T	3.3u	50	7.96	45	0.80	355
AWI4532-3R9□T	3.9u	50	7.96	40	0.90	330
AWI4532-4R7□T	4.7u	50	7.96	35	1.00	315
AWI4532-5R6□T	5.6u	50	7.96	33	1.10	300
AWI4532-6R8□T	6.8u	50	7.96	27	1.20	285
AWI4532-8R2□T	8.2u	50	7.96	25	1.40	270
AWI4532-100□T	10u	50	2.52	20	1.60	250
AWI4532-120□T	12u	50	2.52	18	2.00	225
AWI4532-150□T	15u	50	2.52	17	2.50	200
AWI4532-180□T	18u	50	2.52	15	2.80	190
AWI4532-220□T	22u	50	2.52	13	3.20	180
AWI4532-270□T	27u	50	2.52	12	3.60	170
AWI4532-330□T	33u	50	2.52	11	4.00	160
AWI4532-390□T	39u	50	2.52	10	4.50	150
AWI4532-470□T	47u	50	2.52	10	5.00	140
AWI4532-560□T	56u	50	2.52	9.0	5.50	135
AWI4532-680□T	68u	50	2.52	9.0	6.00	130
AWI4532-820□T	82u	50	2.52	8.0	7.00	120
AWI4532-101□T	100u	40	0.796	8.0	8.00	110
AWI4532-121□T	120u	40	0.796	6.0	8.00	110
AWI4532-151□T	150u	40	0.796	5.0	9.00	105
AWI4532-181□T	180u	40	0.796	5.0	9.50	102
AWI4532-221□T	220u	40	0.796	4.0	10	100
AWI4532-271□T	270u	40	0.796	4.0	12	92
AWI4532-331□T	330u	40	0.796	3.5	14	85
AWI4532-391□T	390u	40	0.796	3.0	18	80
AWI4532-471□T	470u	40	0.796	3.0	26	62
AWI4532-561□T	560u	30	0.796	3.0	30	50
AWI4532-681□T	680u	30	0.796	3.0	30	50
AWI4532-821□T	820u	30	0.796	2.5	35	30
AWI4532-102□T	1000u	30	0.252	2.5	40	30

### NOTE:

- The operating temperature range is -40°C to +85°C
- □ Tolerance K: ±10%, M: ±20%

# EMI SUPPRESSION FILTER

## Features

- Monolithic inorganic material construction.
- Colsed magnetic circuit avoids crosstalk.
- Suitable for flow and reflow soldering.
- Excellent solderability and heat resistance.
- High reliability.

## Applications

Personal computers, communication equipment, digital telephone, electronic games machines, CRTs, hard disk drives, cellular phones, PDAs, printers and other computer peripheral products. Suitable for I/O ports, DC power lines and signal lines, and general circuits with unstable ground.

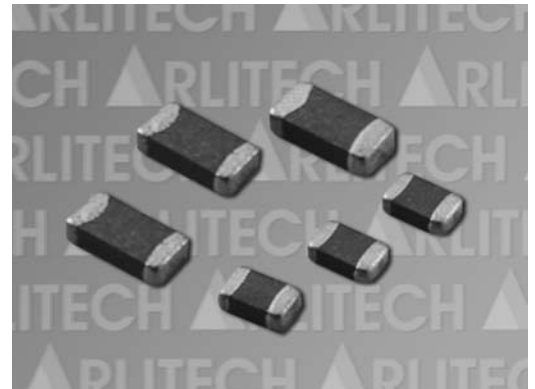

## Shape & Dimensions

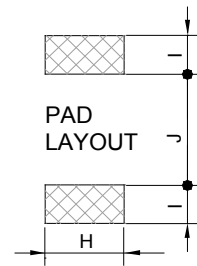
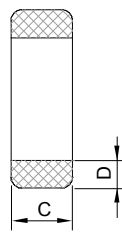
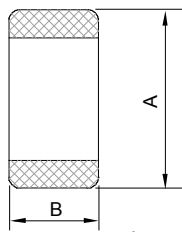

TYPE	A (mm)	B (mm)	C (mm)	D (mm)	H (Ref.)	I (Ref.)	J (Ref.)
AMB1005	1.0±0.1	0.5±0.1	0.5±0.1	0.25±0.2	0.50	0.45	0.50
AMB1608	1.6±0.2	0.8±0.2	0.8±0.2	0.3±0.2	0.70	0.70	0.70
AMB2012	2.0±0.2	1.2±0.2	0.9±0.2	0.5±0.3	1.00	0.80	1.00
AMB3216	3.2±0.2	1.6±0.2	1.1±0.2	0.5±0.3	1.40	1.10	2.20

## Product Identification

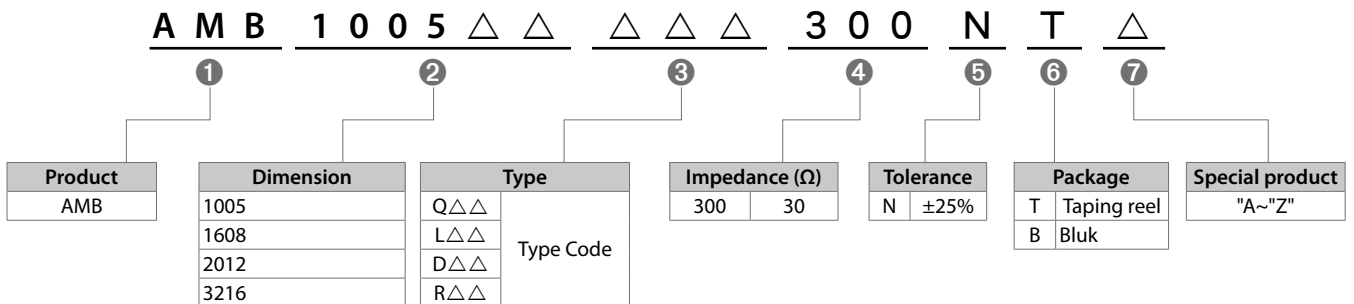

## Specification

Part Number	Impedance ( $\Omega$ )	Test Freq. (MHz)	DCR ( $\Omega$ ) Max.	Rated Current (mA) Max.
<b>AMB1005 Series Specification</b>				
AMB1005Q300□T	30	100	0.3	500
AMB1005Q600□T	60	100	0.4	200
AMB1005Q121□T	120	100	0.5	200
AMB1005Q221□T	220	100	0.7	100
AMB1005Q301□T	300	100	0.8	100
AMB1005Q451□T	450	100	0.9	100
AMB1005Q601□T	600	100	1.0	100

### NOTE:

- The operating temperature range is -55°C to +125°C
- Tolerance N:  $\pm 25\%$

## Typical Impedance v.s. Frequency Curve

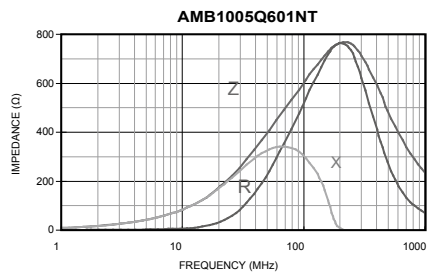
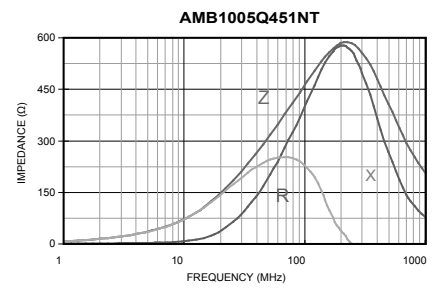
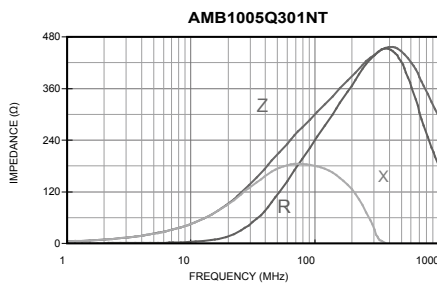
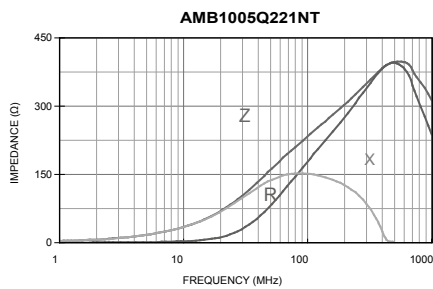
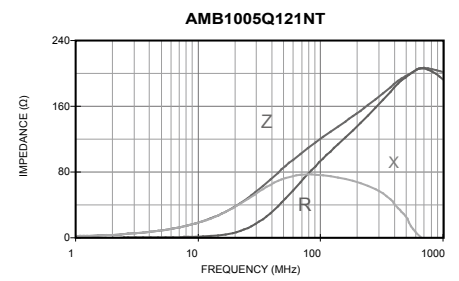
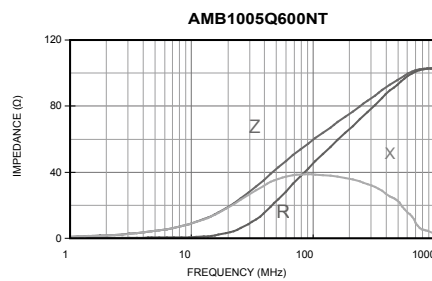
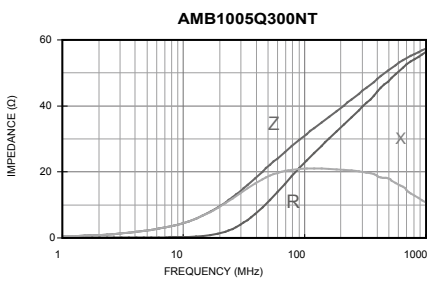

## Specification

Part Number	Impedance ( $\Omega$ )	Test Freq. (MHz)	DCR ( $\Omega$ ) Max.	Rated Current (mA) Max.
<b>AMB1608 Series Specification</b>				
AMB1608Q090□T	9	100	0.20	500
AMB1608Q300□T	30	100	0.30	400
AMB1608Q400□T	40	100	0.30	400
AMB1608Q600□T	60	100	0.30	300
AMB1608Q700□T	70	100	0.30	300
AMB1608Q800□T	80	100	0.30	300
AMB1608Q101□T	100	100	0.30	200
AMB1608Q121□T	120	100	0.30	200
AMB1608Q151□T	150	100	0.30	200
AMB1608Q181□T	180	100	0.30	200
AMB1608Q221□T	220	100	0.30	200
AMB1608Q301□T	300	100	0.35	150
AMB1608Q331□T	330	100	0.35	150
AMB1608Q451□T	450	100	0.40	150
AMB1608Q601□T	600	100	0.45	100
AMB1608Q751□T	750	100	0.50	100
AMB1608Q801□T	800	100	0.55	100
AMB1608Q102□T	1000	100	0.60	100
AMB1608Q122□T	1200	100	0.65	100
AMB1608Q152□T	1500	100	0.70	50
AMB1608L600□T	60	100	0.30	300
AMB1608L800□T	80	100	0.30	300
AMB1608L121□T	120	100	0.30	200
AMB1608L151□T	150	100	0.30	200
AMB1608L221□T	220	100	0.30	200
AMB1608L301□T	300	100	0.35	150
AMB1608L451□T	450	100	0.40	150
AMB1608L601□T	600	100	0.45	100
AMB1608L751□T	750	100	0.50	100
AMB1608L102□T	1000	100	0.60	50
AMB1608L152□T	1500	100	0.70	50
AMB1608L182□T	1800	100	0.75	50
AMB1608L202□T	2000	100	0.80	50
AMB1608L222□T	2200	100	0.85	50
AMB1608D050□T	5	100	0.20	600
AMB1608D150□T	15	100	0.25	500
AMB1608D300□T	30	100	0.30	400
AMB1608D400□T	40	100	0.30	300
AMB1608D600□T	60	100	0.30	300
AMB1608D800□T	80	100	0.30	200
AMB1608D121□T	120	100	0.30	200
AMB1608D181□T	180	100	0.35	150
AMB1608D221□T	220	100	0.40	150
AMB1608D301□T	300	100	0.45	100
AMB1608D401□T	400	100	0.45	100
AMB1608D601□T	600	100	0.65	50
AMB1608D102□T	1000	100	0.80	50

## NOTE:

- The operating temperature range is  $-55^{\circ}\text{C}$  to  $+125^{\circ}\text{C}$
- □ Tolerance N:  $\pm 25\%$

## Typical Impedance v.s. Frequency Curve

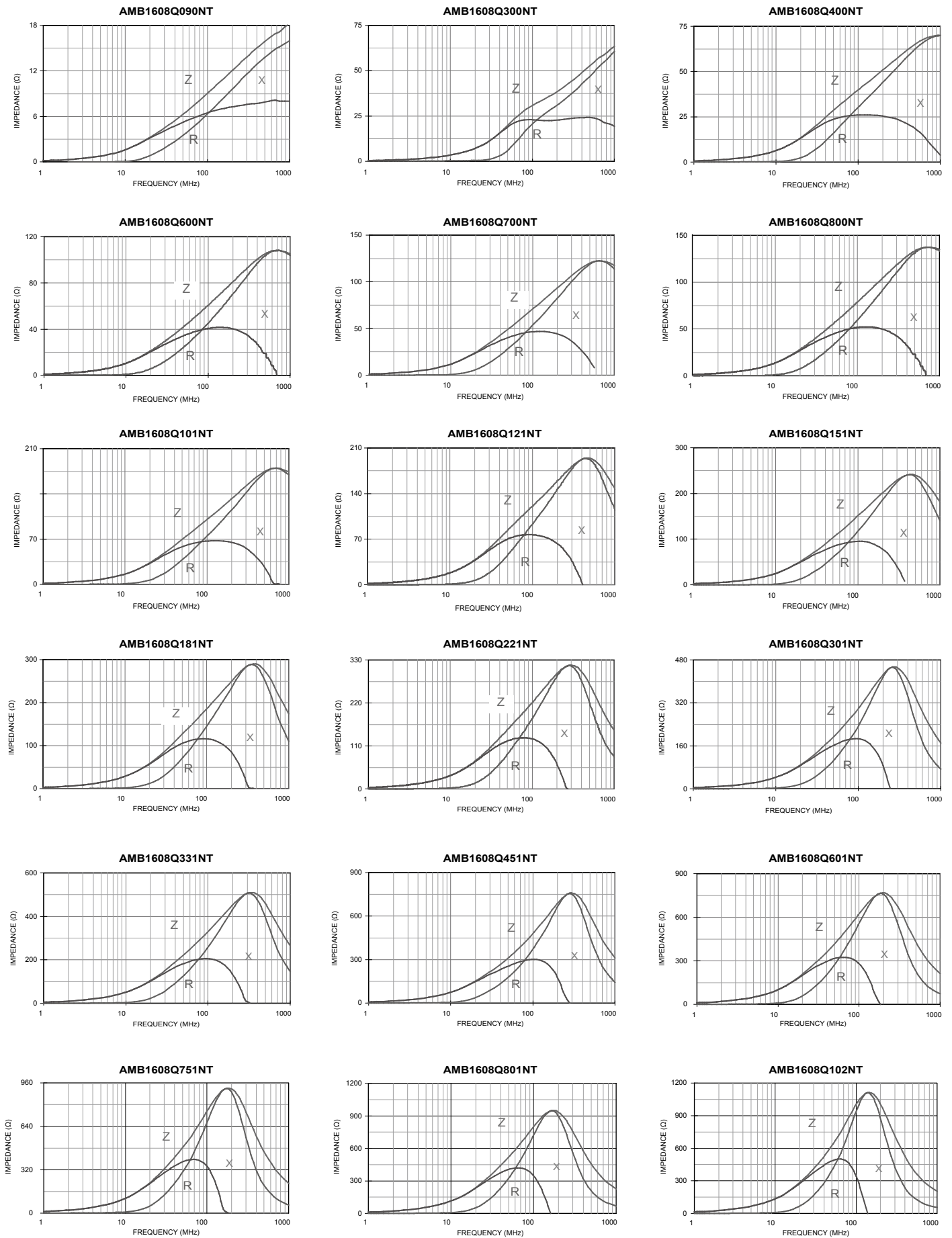



## Typical Impedance v.s. Frequency Curve

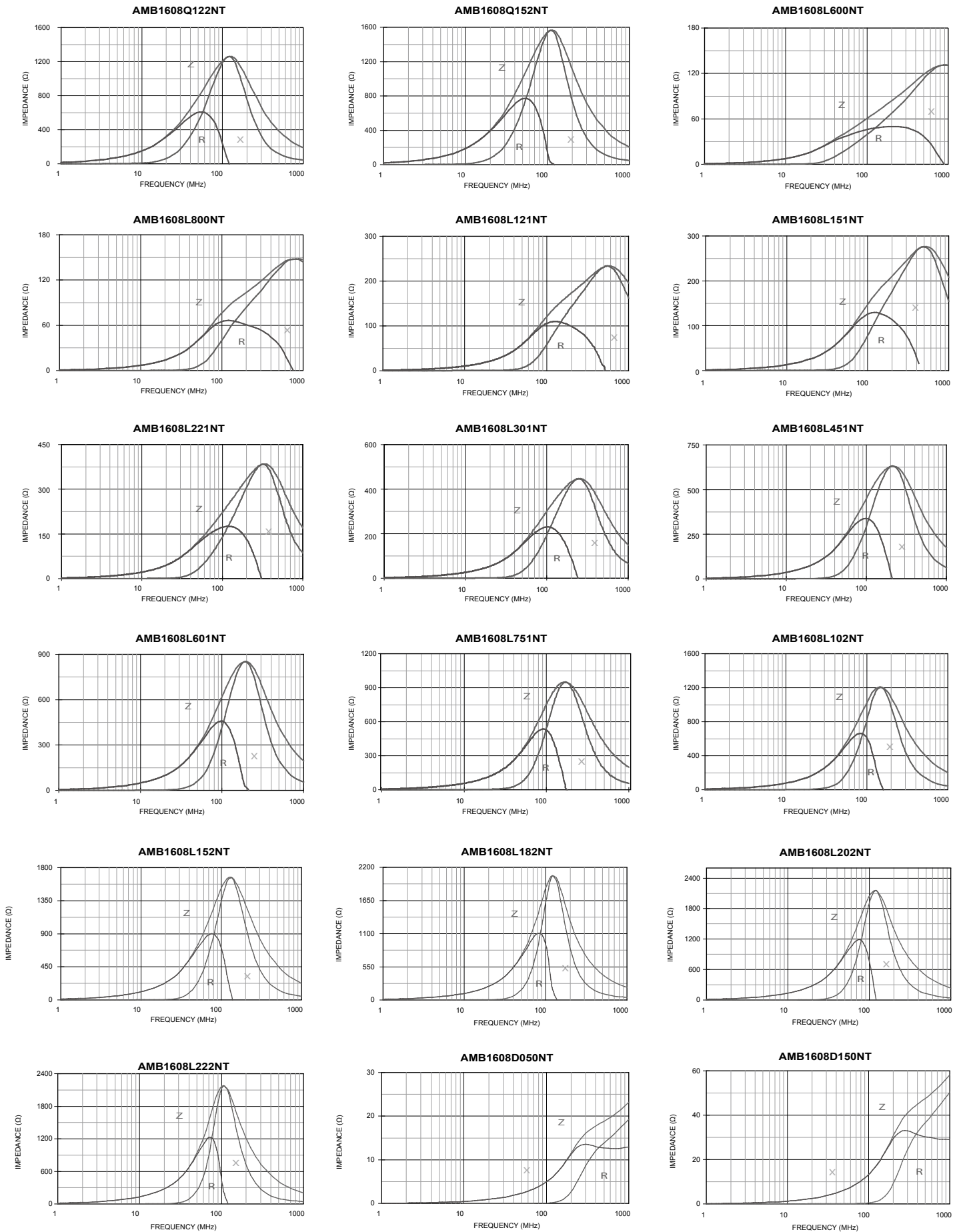

## Typical Impedance v.s. Frequency Curve

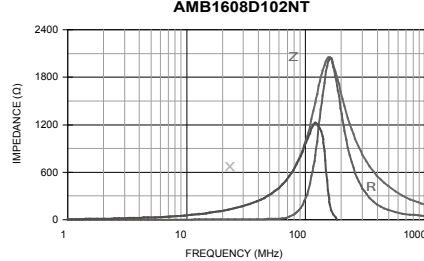
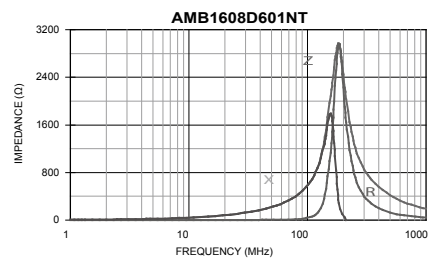
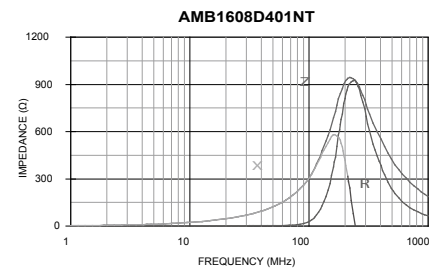
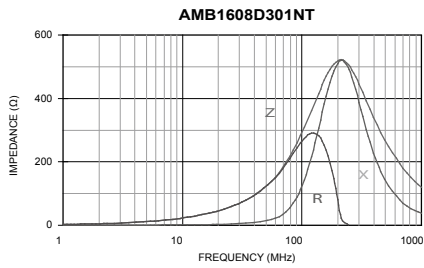
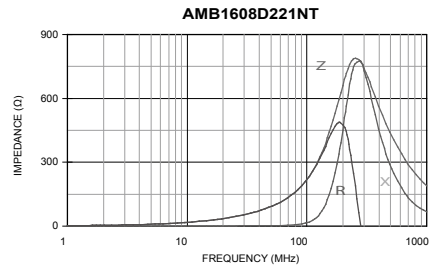
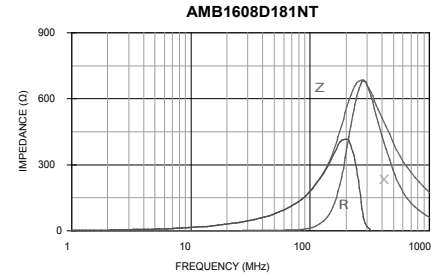
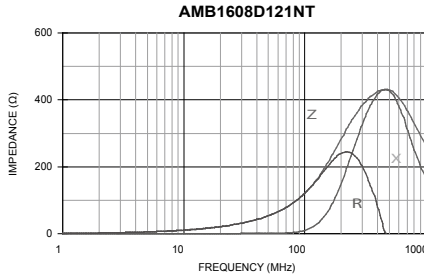
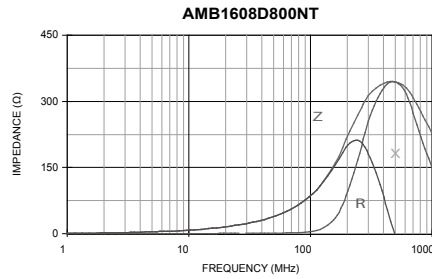
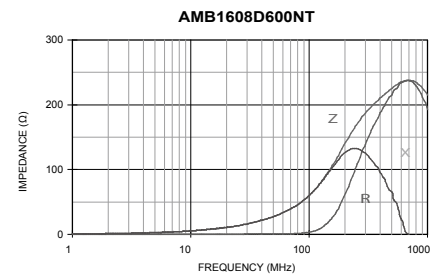
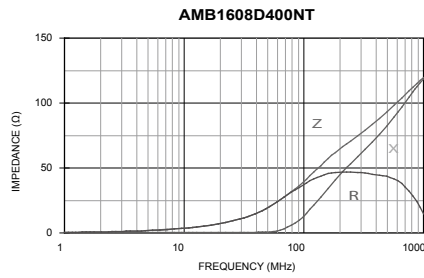
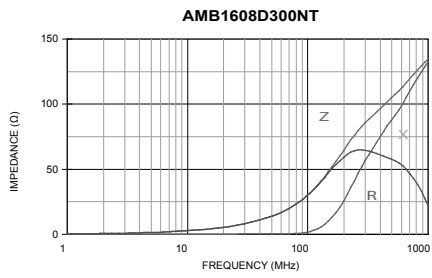

## Specification

Part Number	Impedance ( $\Omega$ )	Test Freq. (MHz)	DCR ( $\Omega$ ) Max.	Rated Current (mA) Max.
<b>AMB2012 Series Specification</b>				
AMB2012Q070□T	7	100	0.15	600
AMB2012Q170□T	17	100	0.20	600
AMB2012Q320□T	32	100	0.20	400
AMB2012Q400□T	40	100	0.20	300
AMB2012Q600□T	60	100	0.20	300
AMB2012Q800□T	80	100	0.20	300
AMB2012Q121□T	120	100	0.25	300
AMB2012Q151□T	150	100	0.25	300
AMB2012Q201□T	200	100	0.30	200
AMB2012Q221□T	220	100	0.30	200
AMB2012Q301□T	300	100	0.30	200
AMB2012Q401□T	400	100	0.35	200
AMB2012Q501□T	500	100	0.35	200
AMB2012Q601□T	600	100	0.35	100
AMB2012Q102□T	1000	100	0.45	100
AMB2012Q122□T	1200	100	0.45	100
AMB2012L300□T	30	100	0.20	400
AMB2012L600□T	60	100	0.20	300
AMB2012L800□T	80	100	0.20	300
AMB2012L121□T	120	100	0.25	300
AMB2012L151□T	150	100	0.25	300
AMB2012L201□T	200	100	0.30	200
AMB2012L221□T	220	100	0.30	200
AMB2012L301□T	300	100	0.30	200
AMB2012L401□T	400	100	0.35	200
AMB2012L501□T	500	100	0.35	200
AMB2012L601□T	600	100	0.40	100
AMB2012L751□T	750	100	0.40	100
AMB2012L102□T	1000	100	0.45	100
AMB2012L122□T	1200	100	0.50	100
AMB2012L152□T	1500	100	0.45	200
AMB2012L202□T	2000	100	0.60	200
AMB2012L222□T	2200	100	0.60	200
AMB2012D070□T	7	100	0.20	600
AMB2012D400□T	40	100	0.20	300
AMB2012D600□T	60	100	0.25	300
AMB2012D800□T	80	100	0.25	300
AMB2012D121□T	120	100	0.30	200
AMB2012D151□T	150	100	0.35	200
AMB2012D181□T	180	100	0.35	200
AMB2012D201□T	200	100	0.35	200
AMB2012D221□T	220	100	0.35	200
AMB2012D301□T	300	100	0.40	100
AMB2012D601□T	600	100	0.50	100
AMB2012D102□T	1000	100	0.60	50

## NOTE:

- The operating temperature range is -55°C to +125°C
- □ Tolerance N:  $\pm 25\%$

## Typical Impedance v.s. Frequency Curve

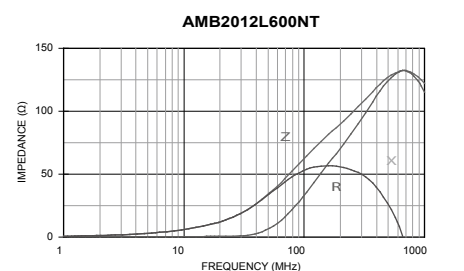
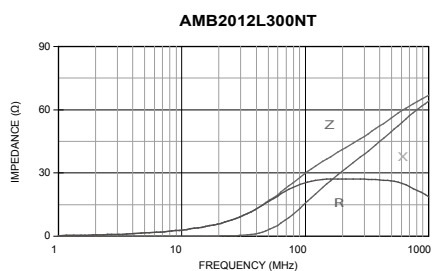
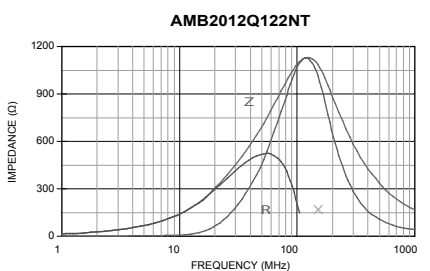
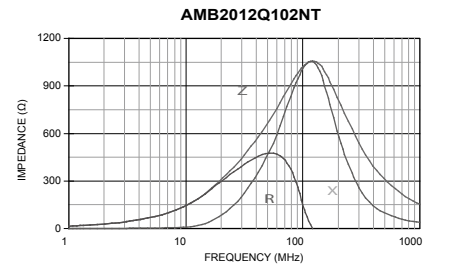
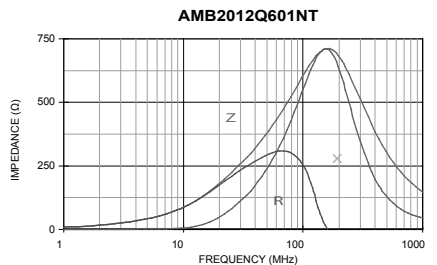
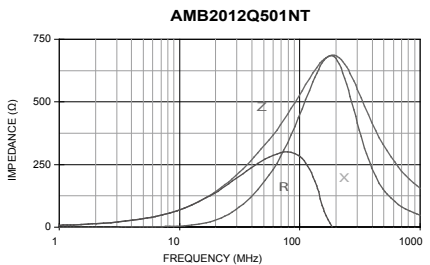
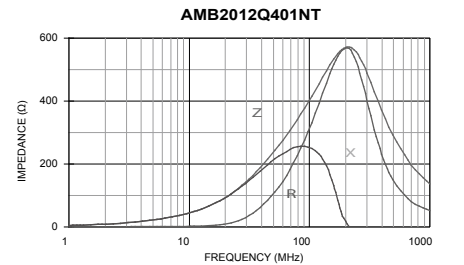
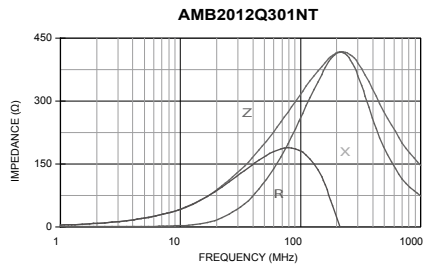
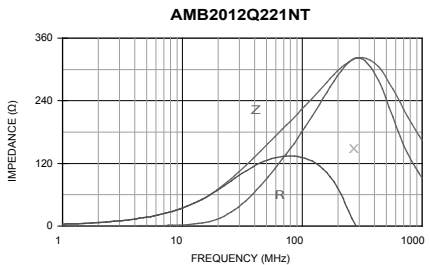
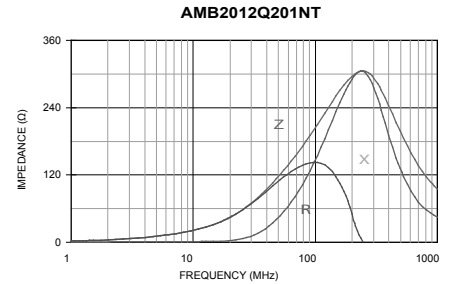
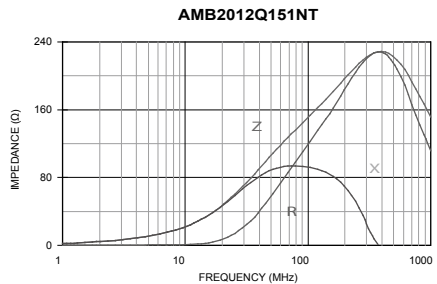
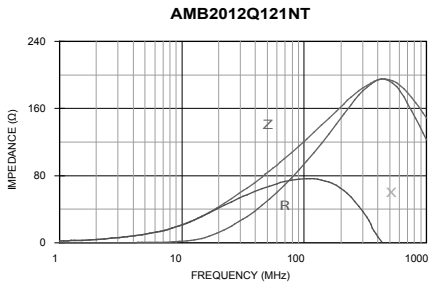
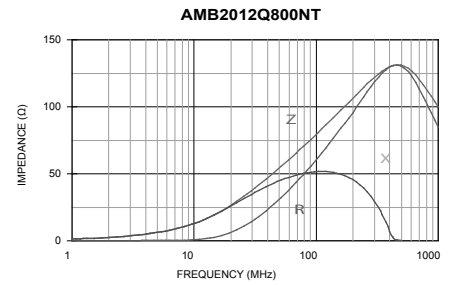
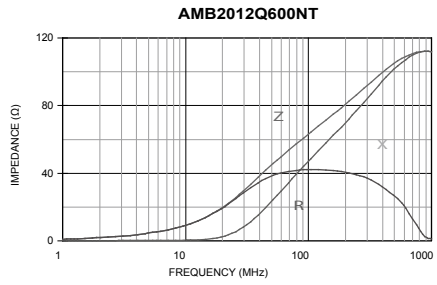
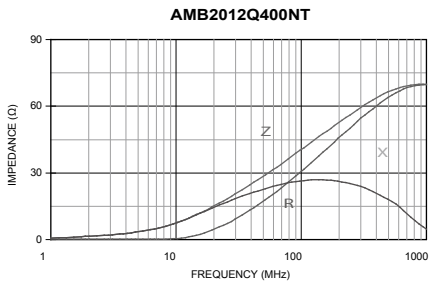
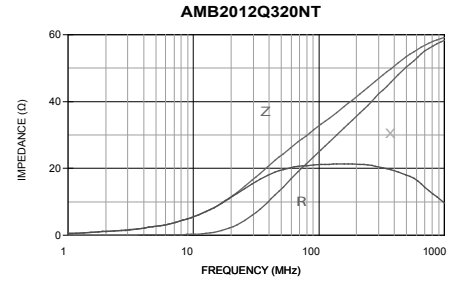
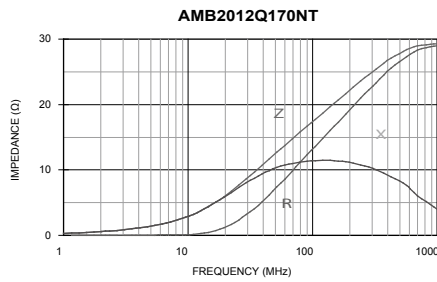
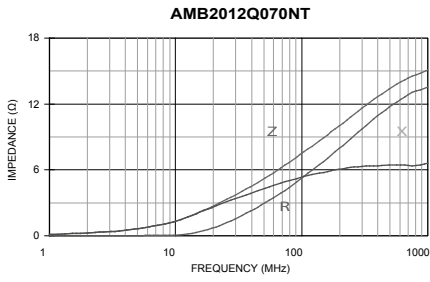

## Typical Impedance v.s. Frequency Curve

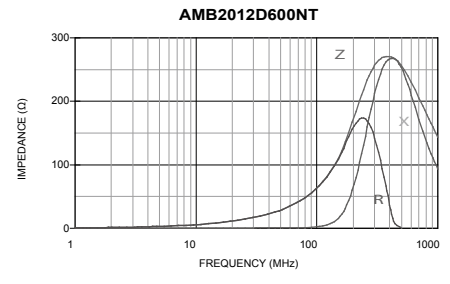
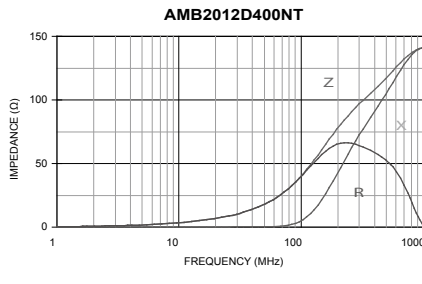
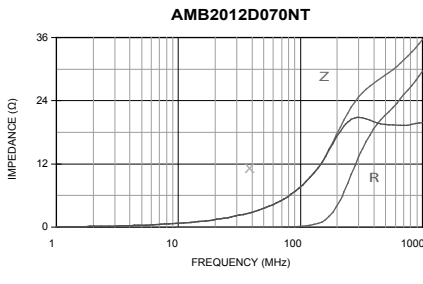
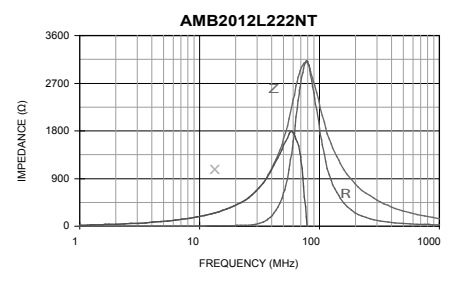
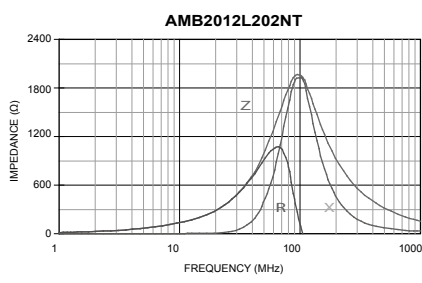
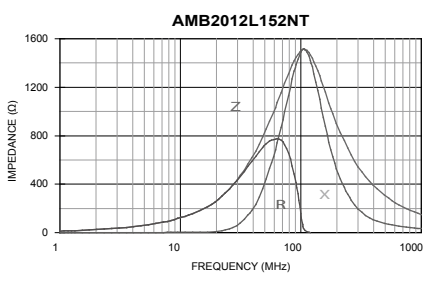
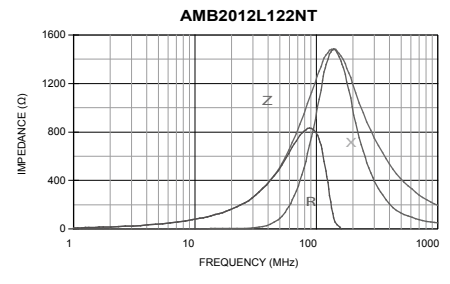
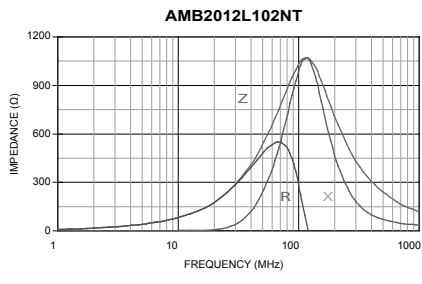
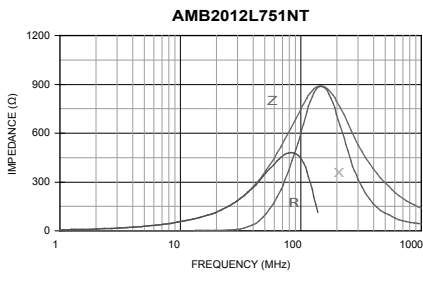
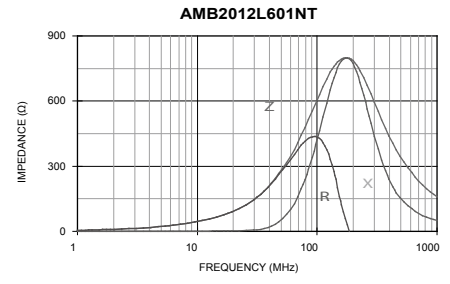
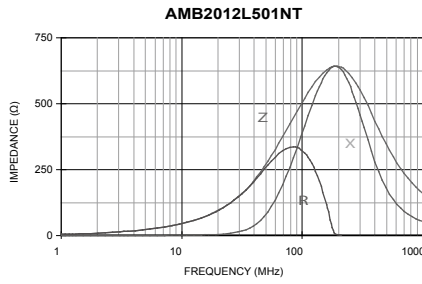
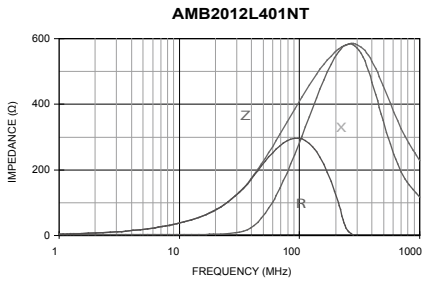
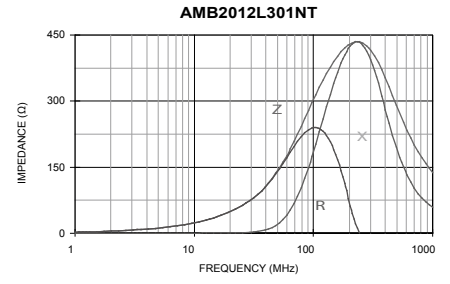
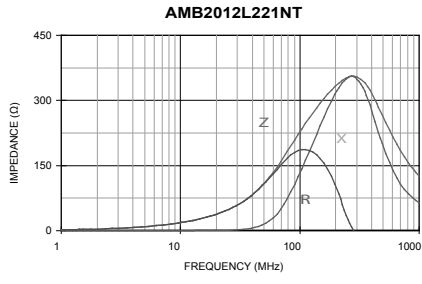
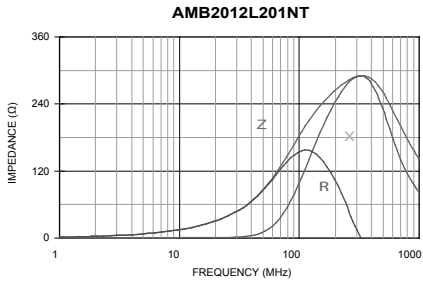
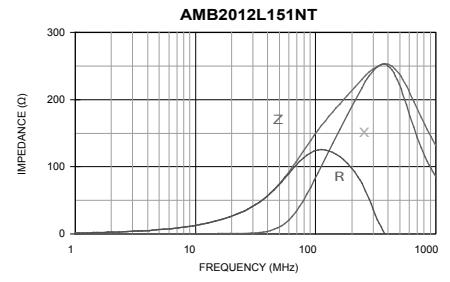
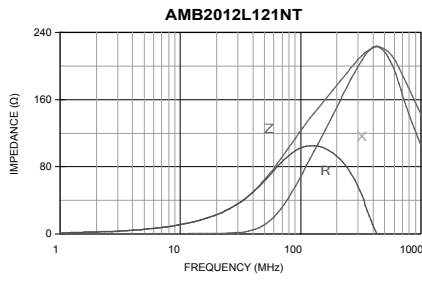
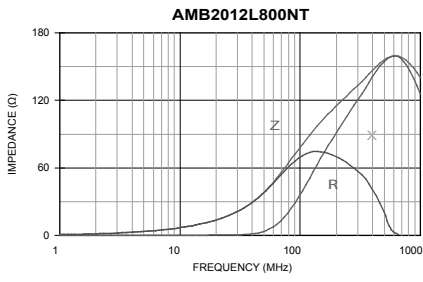

## Typical Impedance v.s. Frequency Curve

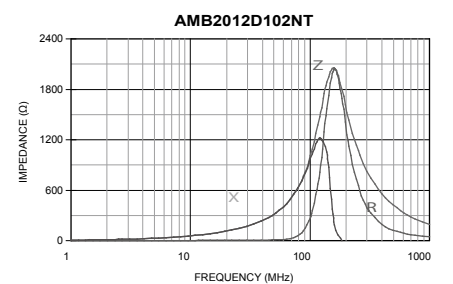
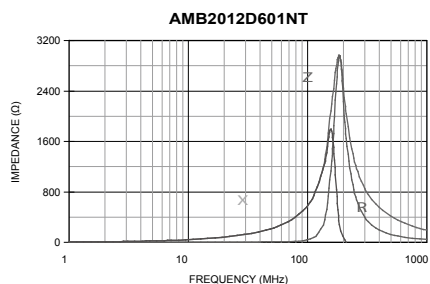
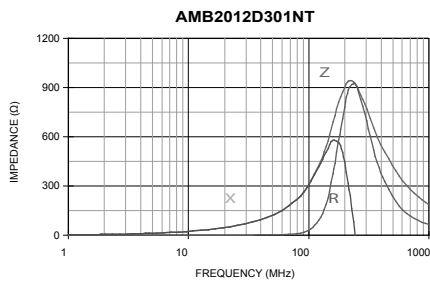
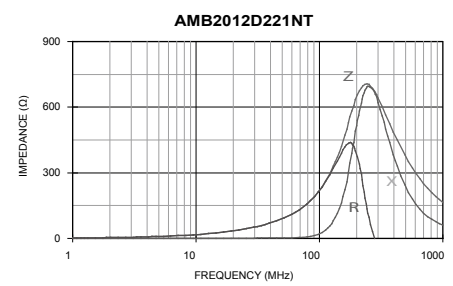
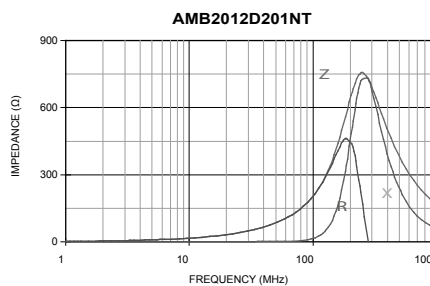
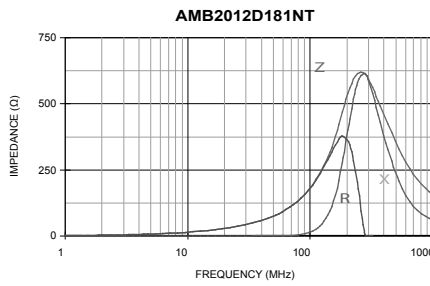
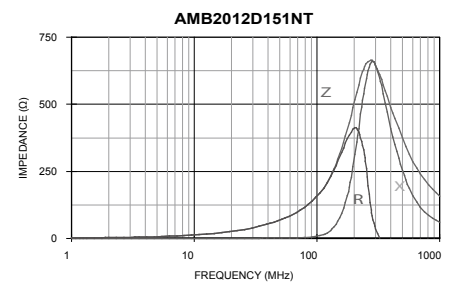
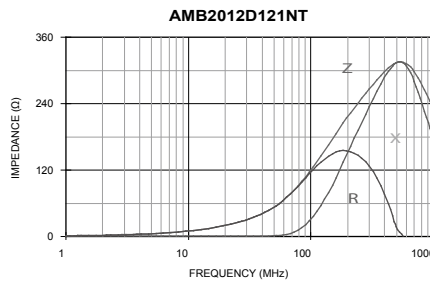
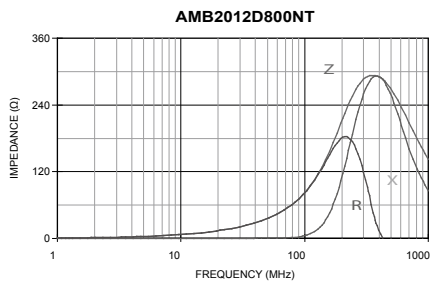

## Specification

Part Number	Impedance (Ω)	Test Frequency (MHz)	DCR (Ω) Max.	Rated Current (mA) Max.
<b>AMB3216 Series Specification</b>				
AMB3216Q310□T	31	100	0.2	500
AMB3216Q600□T	60	100	0.3	400
AMB3216Q900□T	90	100	0.3	300
AMB3216Q151□T	150	100	0.3	300
AMB3216Q301□T	300	100	0.3	300
AMB3216Q601□T	600	100	0.3	200
AMB3216Q122□T	1200	50	0.5	100
AMB3216Q202□T	2000	30	0.7	100
AMB3216L151□T	150	100	0.3	300
AMB3216L301□T	300	100	0.3	300
AMB3216L601□T	600	100	0.3	200
AMB3216D190□T	19	100	0.2	500

### NOTE:

- The operating temperature range is -55°C to +125°C
- Tolerance N: ±25%

## Typical Impedance v.s. Frequency Curve

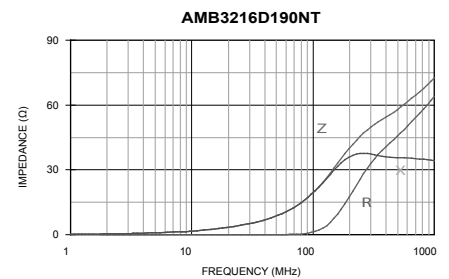
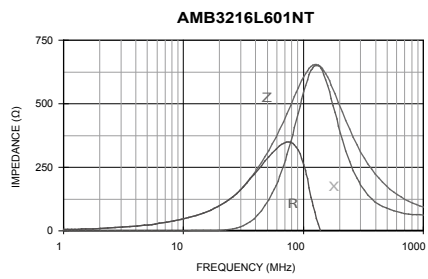
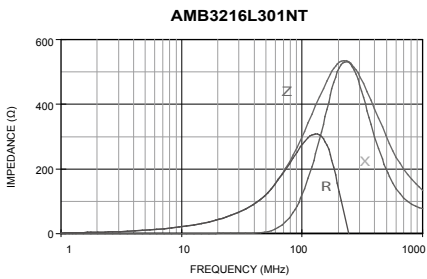
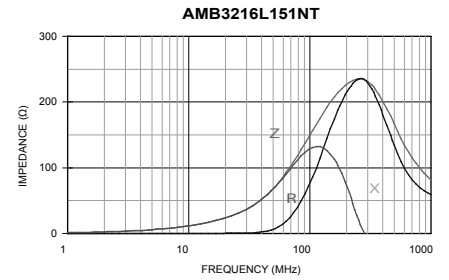
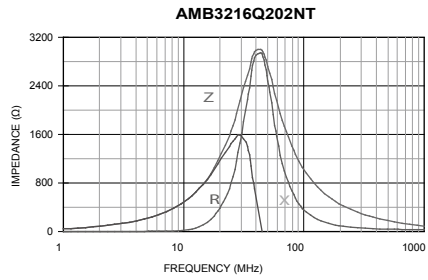
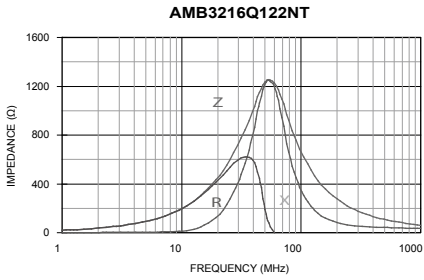
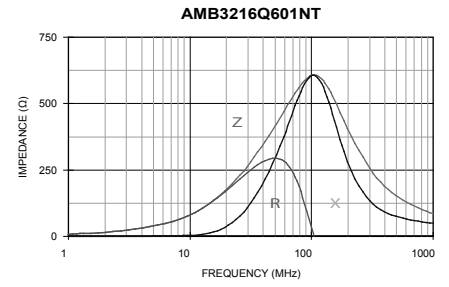
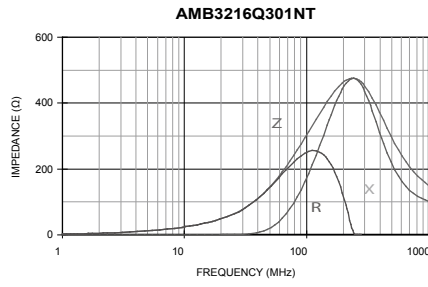
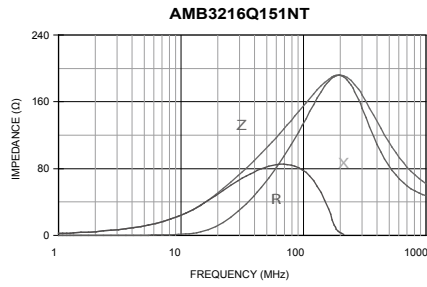
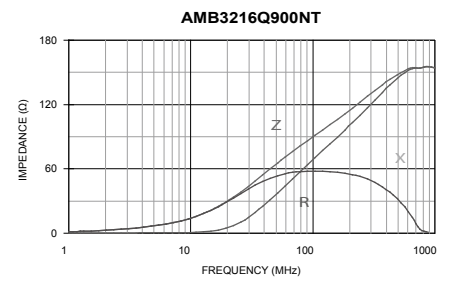
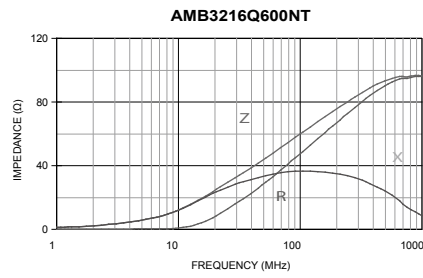
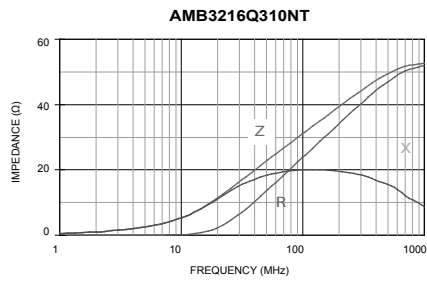



# EMI SUPPRESSION FILTER

## Features

Combination of high frequency noise suppression with capability of handling high current.  
The current rating up to 6 Amps with low DCR.

## Applications

- High current DC power lines
- Circuits where a stable ground is unavailable

## Shape & Dimensions

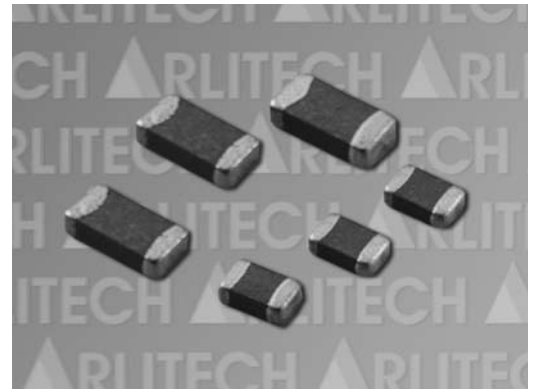
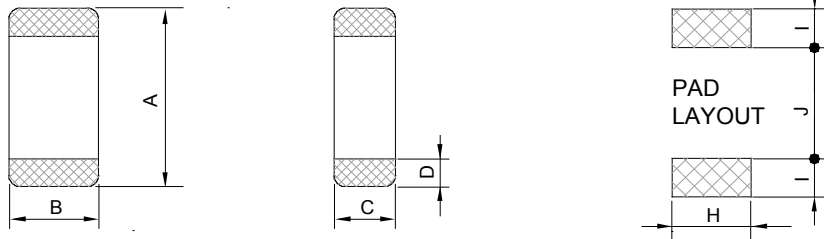

TYPE	A (mm)	B (mm)	C (mm)	D (mm)	H (Ref.)	I (Ref.)	J (Ref.)
AMC1005	1.0±0.1	0.5±0.1	0.5±0.1	0.25±0.15	0.6	0.6	0.6
AMC1608	1.6±0.2	0.8±0.2	0.8±0.2	0.3±0.2	0.7	0.7	0.7
AMC2012	2.0±0.2	1.2±0.2	0.9±0.2	0.5±0.3	1.0	0.8	1.0

## Product Identification

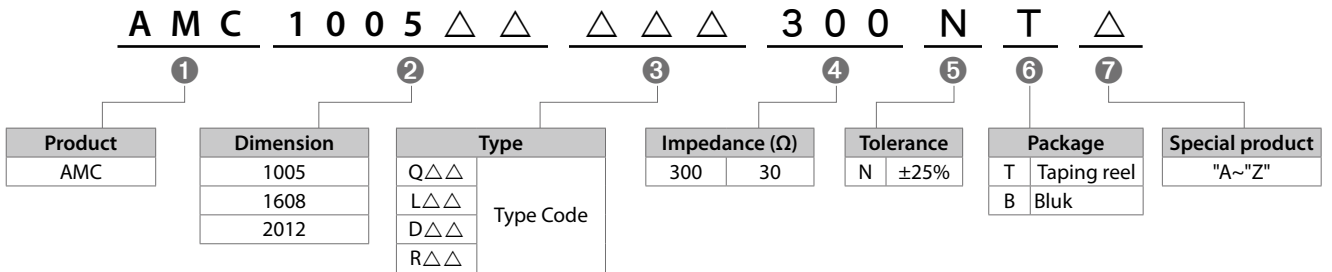

## Specification

Part Number	Impedance (Ω)	Test Freq. (MHz)	DCR (Ω) Max.	Rated Current (A) Max.
<b>AMC1005 Series Specification</b>				
AMC1005Q100□T	10	100	0.05	1.0
AMC1005Q300□T	30	100	0.15	2.0
AMC1005Q121□T	120	100	0.20	1.2

**NOTE:**

- The operating temperature range is -55°C to +125°C
- □ Tolerance N: ±25%

## Typical Impedance v.s. Frequency Curve

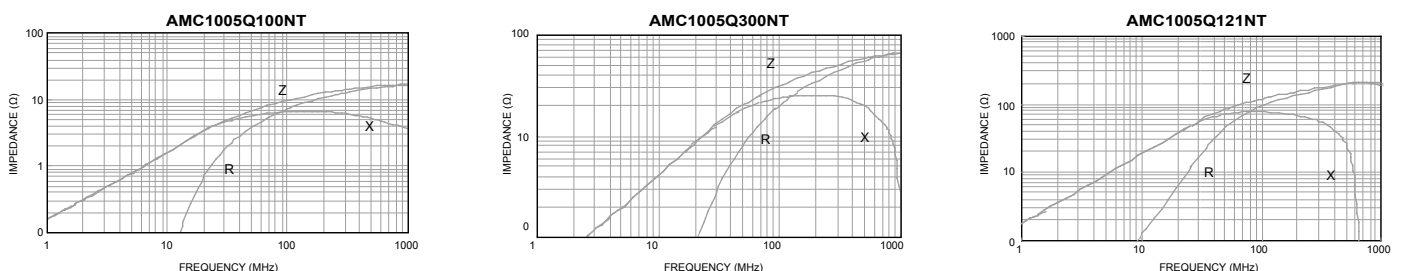

## Specification

Part Number	Impedance ( $\Omega$ )	Test Freq. (MHz)	DCR ( $\Omega$ ) Max.	Rated Current (A) Max.
<b>AMC1608 Series Specification</b>				
AMC1608Q300□T	30	100	30 m	3.0
AMC1608Q600□T	60	100	40 m	3.0
AMC1608Q121□T	120	100	100 m	2.5
AMC1608Q301□T	300	100	150 m	2.0
AMC1608Q601□T	600	100	200 m	1.0
<b>AMC2012 Series Specification</b>				
AMC2012Q170□T	17	100	25 m	3.0
AMC2012Q300□T	30	100	25 m	3.0
AMC2012Q121□T	120	100	60 m	3.0
AMC2012Q301□T	300	100	100 m	2.0
AMC2012Q601□T	600	100	150 m	2.0

### NOTE:

- The operating temperature range is  $-55^{\circ}\text{C}$  to  $+125^{\circ}\text{C}$
- □ Tolerance N:  $\pm 25\%$

## Typical Impedance v.s. Frequency Curve

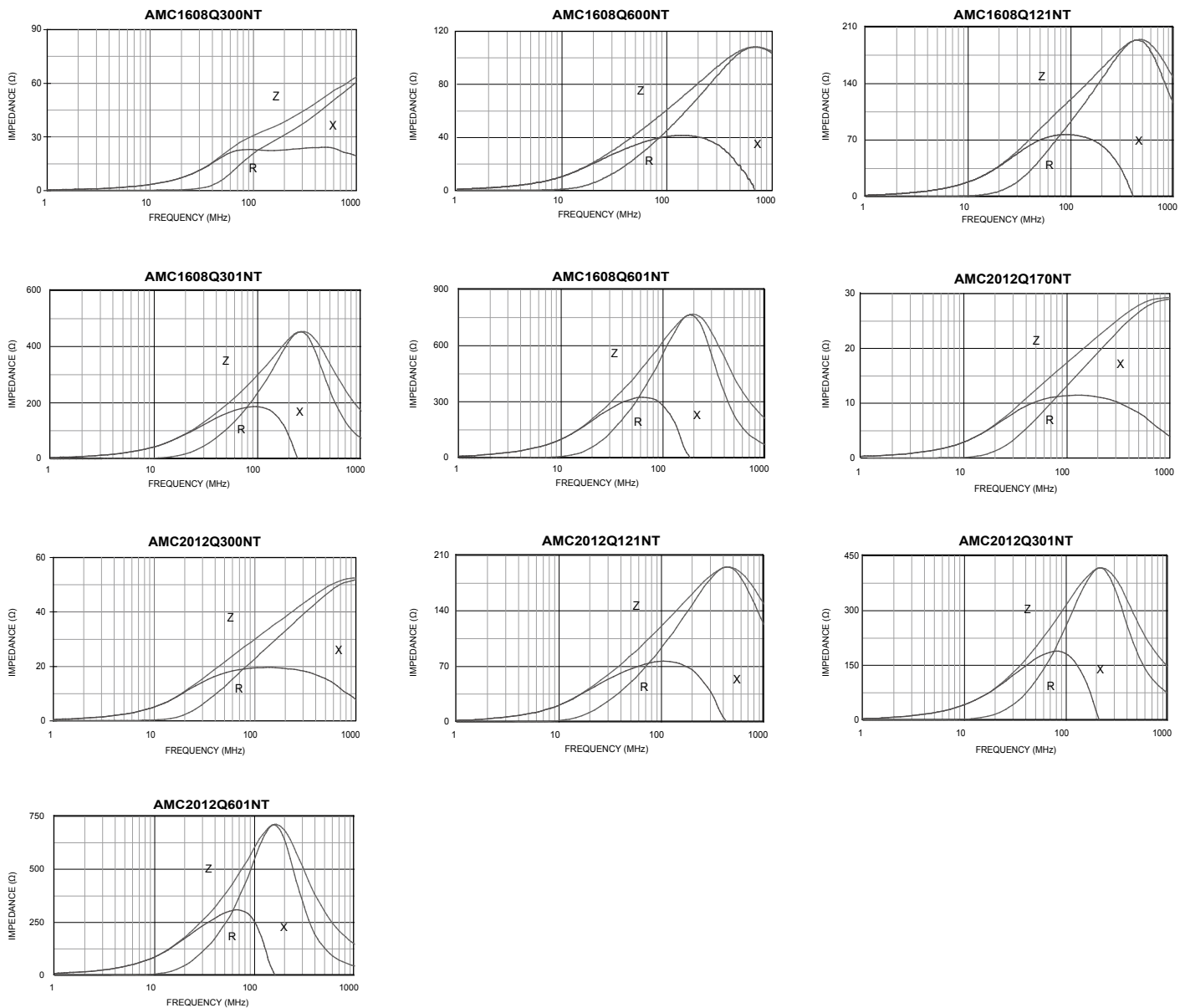

# EMI SUPPRESSION FILTER

## Features

Combines 4 single 1608(0603) chips into one package 3216(1206) to reduce board space, and placement time 0.8mm terminal pitch makes easy to apply EMI prevention in multiple-lines such as connectors and IC pins.

Material and construction design minimize cross talk between adjacent circuits.

## Applications

Filtering between analog and digital circuitry, clock generation circuitry, I/O interconnects, isolation between RF noisy circuits and logic devices susceptible to functional degradation, power supply filtering to prevent conducted RF energy from corrupting the power generation circuitry, high frequency EMI prevention of computers, printers, VCRs, TVs and portable telephones



## Shape & Dimensions

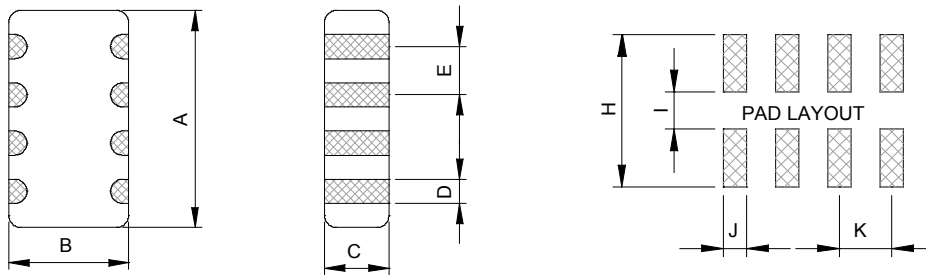

TYPE	A (mm)	B (mm)	C (mm)	D (mm)	E (mm)	H (Ref.)	I (Ref.)	J (Ref.)	K (Ref.)
AMA3216	3.2±0.2	1.6±0.2	0.9±0.2	0.4±0.2	0.8±0.1	2.6	0.6	0.4	0.8

## Product Identification

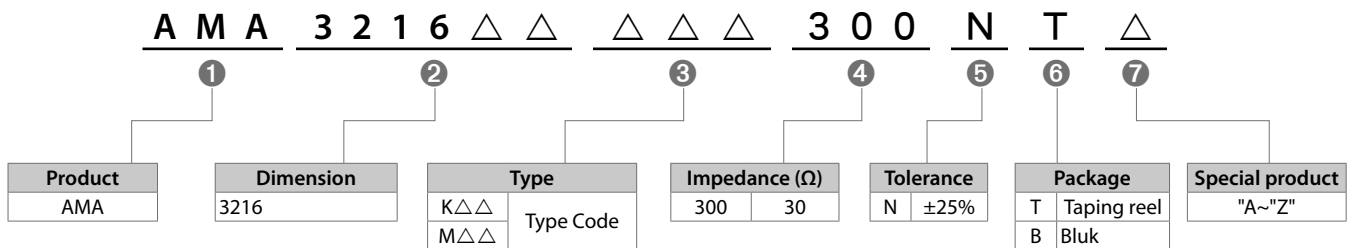

## Specification

Part Number	Impedance (Ω)	Test Freq. (MHz)	DCR (Ω) Max.	Rated Current (mA) Max.
<b>AMA3216 Series Specification</b>				
AMA3216K300□T	30	100	0.20	500
AMA3216K600□T	60	100	0.25	400
AMA3216K121□T	120	100	0.30	350
AMA3216K151□T	150	100	0.35	250
AMA3216K221□T	220	100	0.35	250
AMA3216K301□T	300	100	0.40	250
AMA3216K471□T	470	100	0.50	200
AMA3216K601□T	600	100	0.50	200
AMA3216K121□T	1200	100	0.75	150
AMA3216M800□T	80	100	0.30	350
AMA3216M121□T	120	100	0.40	250
AMA3216M221□T	220	100	0.45	200
AMA3216M301□T	300	100	0.50	200
AMA3216M471□T	470	100	0.55	200

**NOTE:**

- The operating temperature range is -55°C to +125°C
- □ Tolerance N: ±25%

## Typical Impedance v.s. Frequency Curve

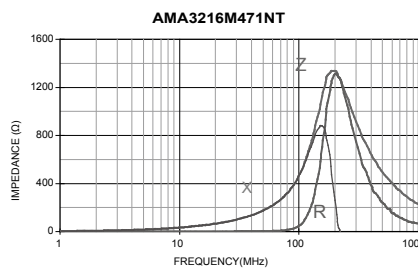
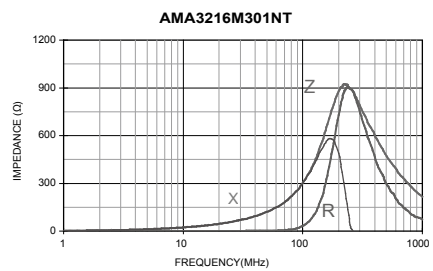
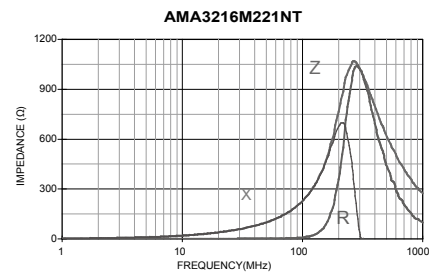
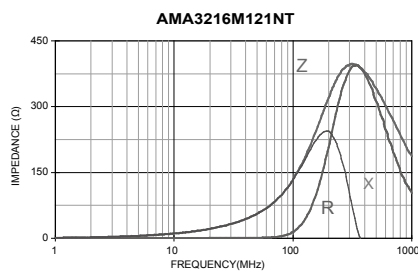
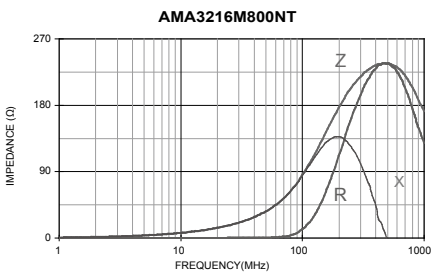
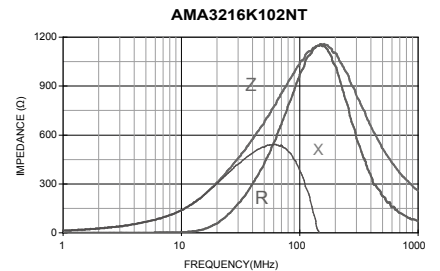
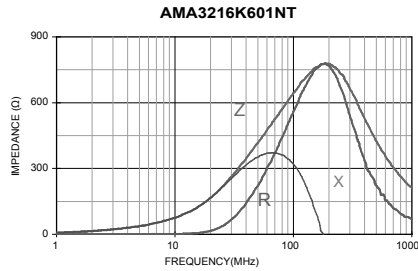
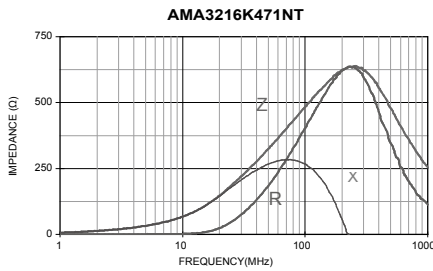
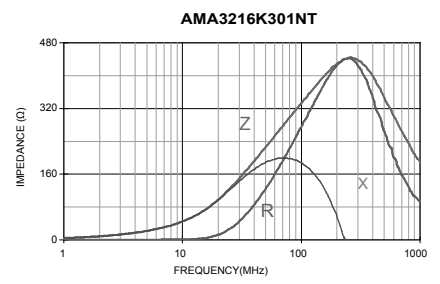
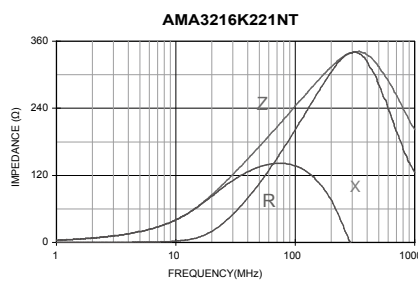
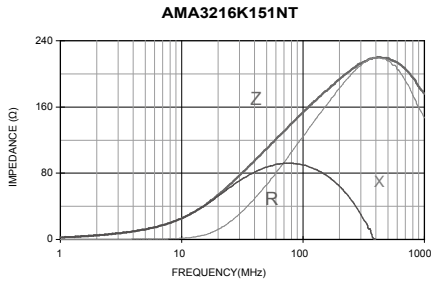
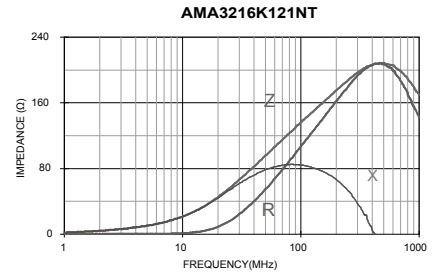
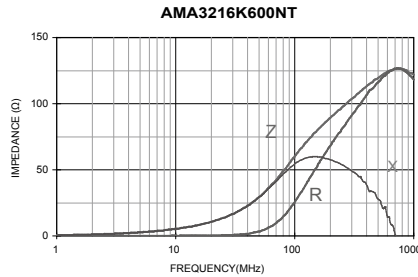
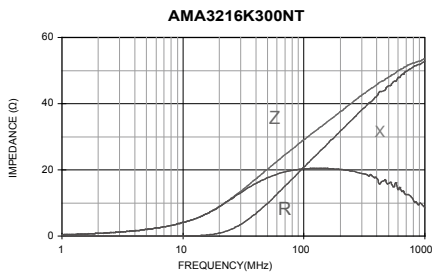

**Features**

Two functional areas include resonant circuits and chokes requireuse of an inductor.

**Applications**

RF and wireless communication, information technology equipment which includes computer, telecommunications, radar detectors, automotive electronics, cellular phones, pagers, audio equipment, PDAs, keyless remote system and low-voltage power supply modules.

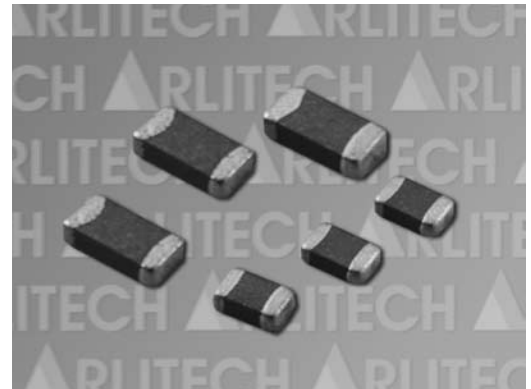

**Shape & Dimensions**

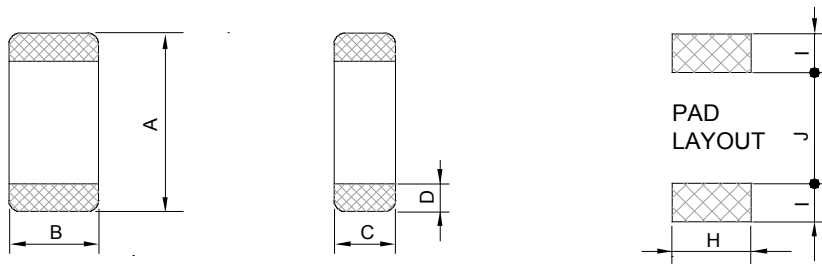

TYPE	A (mm)	B (mm)	C (mm)	D (mm)	H (Ref.)	I (Ref.)	J (Ref.)
AIG1608	1.6±0.2	0.8±0.2	0.8±0.2	0.3±0.2	0.80	1.00	0.60
AIG2012	2.0±0.2	1.25±0.2	0.9±0.2	0.5±0.3	1.00	1.00	1.00
AIG3216	3.2±0.2	1.6±0.2	1.1±0.2	0.5±0.3	1.40	1.10	2.20

**Product Identification**

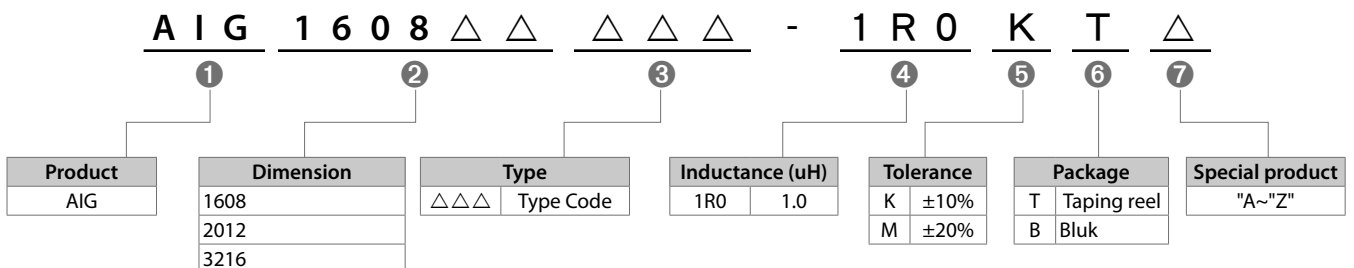

### Specification

Part Number	Inductance (H)	Q Min.	Test Freq. (MHz)	SRF (MHz)	DCR (Ω) Max.	Rated Current (mA) Max.
<b>AIG1608 Series Specification</b>						
AIG1608-47N□T	47 n	10	50	260	0.30	50
AIG1608-68N□T	68 n	10	50	250	0.30	50
AIG1608-R10□T	100 n	15	25	240	0.50	50
AIG1608-R12□T	120 n	15	25	205	0.50	50
AIG1608-R15□T	150 n	15	25	180	0.60	50
AIG1608-R18□T	180 n	15	25	165	0.60	50
AIG1608-R22□T	220 n	15	25	150	0.80	50
AIG1608-R27□T	270 n	15	25	136	0.80	50
AIG1608-R33□T	330 n	15	25	125	0.85	35
AIG1608-R39□T	390 n	15	25	110	1.00	35
AIG1608-R47□T	470 n	15	25	105	1.35	35
AIG1608-R56□T	560 n	15	25	95	1.55	35
AIG1608-R68□T	680 n	15	25	90	1.70	35
AIG1608-R82□T	820 n	15	25	85	2.10	35
AIG1608-1R0□T	1.0u	35	10	75	0.60	25
AIG1608-1R2□T	1.2u	35	10	65	0.80	25
AIG1608-1R5□T	1.5u	35	10	60	0.80	25
AIG1608-1R8□T	1.8u	35	10	55	0.95	25
AIG1608-2R2□T	2.2u	35	10	50	1.15	15
AIG1608-2R7□T	2.7u	35	10	45	1.35	15
AIG1608-3R3□T	3.3u	35	10	40	1.55	15
AIG1608-3R9□T	3.9u	35	10	35	1.70	15
AIG1608-4R7□T	4.7u	35	10	33	2.10	15
AIG1608-5R6□T	5.6u	35	4	22	1.55	5
AIG1608-6R8□T	6.8u	35	4	20	1.70	5
AIG1608-8R2□T	8.2u	35	4	18	2.10	5
AIG1608-100□T	10u	30	2	17	1.85	3
<b>AIG2012 Series Specification</b>						
AIG2012-47N□T	47 n	15	50	320	0.20	300
AIG2012-68N□T	68 n	15	50	280	0.20	300
AIG2012-R10□T	100 n	20	25	235	0.30	250
AIG2012-R12□T	120 n	20	25	220	0.30	250
AIG2012-R15□T	150 n	20	25	200	0.40	250
AIG2012-R18□T	180 n	20	25	185	0.40	250
AIG2012-R22□T	220 n	20	25	170	0.50	250
AIG2012-R27□T	270 n	20	25	150	0.50	250
AIG2012-R33□T	330 n	20	25	145	0.55	250
AIG2012-R39□T	390 n	25	25	135	0.65	200
AIG2012-R47□T	470 n	25	25	125	0.65	200
AIG2012-R56□T	560 n	25	25	115	0.75	150
AIG2012-R68□T	680 n	25	25	105	0.80	150
AIG2012-R82□T	820 n	25	25	100	1.00	150
AIG2012-1R0□T	1.0u	45	10	75	0.40	50
AIG2012-1R2□T	1.2u	45	10	65	0.50	50
AIG2012-1R5□T	1.5u	45	10	60	0.50	50
AIG2012-1R8□T	1.8u	45	10	55	0.60	50
AIG2012-2R2□T	2.2u	45	10	50	0.65	30
AIG2012-2R7□T	2.7u	45	10	45	0.75	30
AIG2012-3R3□T	3.3u	45	10	41	0.80	30
AIG2012-3R9□T	3.9u	45	10	38	0.90	30
AIG2012-4R7□T	4.7u	45	10	35	1.00	30
AIG2012-5R6□T	5.6u	50	4	32	0.90	15
AIG2012-6R8□T	6.8u	50	4	29	1.00	15
AIG2012-8R2□T	8.2u	50	4	26	1.10	15
AIG2012-100□T	10u	50	2	24	1.15	15

**NOTE:**

• The operating temperature range is -40°C to +85°C    • □ Tolerance K: ±10%, M: ±20%

### Specification

Part Number	Inductance (H)	Q Min.	Test Freq. (MHz)	SRF (MHz)	DCR ( $\Omega$ ) Max.	Rated Current (mA) Max.
<b>AIG3216 Series Specification</b>						
AIG3216-47N□T	47 n	20	50	320	0.15	300
AIG3216-68N□T	68 n	20	50	280	0.25	300
AIG3216-R10□T	100 n	20	25	235	0.25	250
AIG3216-R12□T	120 n	20	25	220	0.30	250
AIG3216-R15□T	150 n	20	25	200	0.30	250
AIG3216-R18□T	180 n	20	25	185	0.40	250
AIG3216-R22□T	220 n	20	25	170	0.40	250
AIG3216-R27□T	270 n	20	25	150	0.50	250
AIG3216-R33□T	330 n	20	25	145	0.60	250
AIG3216-R39□T	390 n	25	25	135	0.50	200
AIG3216-R47□T	470 n	25	25	125	0.60	200
AIG3216-R56□T	560 n	25	25	115	0.70	150
AIG3216-R68□T	680 n	25	25	105	0.80	150
AIG3216-R82□T	820 n	25	25	100	0.90	150
AIG3216-1R0□T	1.0u	10	10	75	0.40	100
AIG3216-1R2□T	1.2u	10	10	65	0.50	100
AIG3216-1R5□T	1.5u	10	10	60	0.50	50
AIG3216-1R8□T	1.8u	10	10	55	0.50	50
AIG3216-2R2□T	2.2u	10	10	50	0.60	50
AIG3216-2R7□T	2.7u	10	10	45	0.60	50
AIG3216-3R3□T	3.3u	10	10	41	0.70	50
AIG3216-3R9□T	3.9u	10	10	38	0.80	50
AIG3216-4R7□T	4.7u	10	10	35	0.90	50
AIG3216-5R6□T	5.6u	4	4	32	0.70	25
AIG3216-6R8□T	6.8u	4	4	29	0.80	25
AIG3216-8R2□T	8.2u	4	4	26	0.90	25
AIG3216-100□T	10u	2	2	24	1.00	25

#### NOTE:

- The operating temperature range is -40°C to +85°C
- □ Tolerance K:  $\pm 10\%$ , M:  $\pm 20\%$



**Features**

- Excellent Q factor and SRF characteristics
- Small size of 1005/1608 is suitable for small portable equipment.
- Supports operating frequency bands up to 6GHz with nominal inductance values from 1.0nH To 470nH.

**Applications**

- RF Resonance and Impedance Matching Circuit
- RF and wireless communication
- Information technology equipments, computers, telecommunications, radar detectors, automotive electronics, cellular phones, pagers, PDAs, keyless remote systems.
- Use in L-C filter configurations

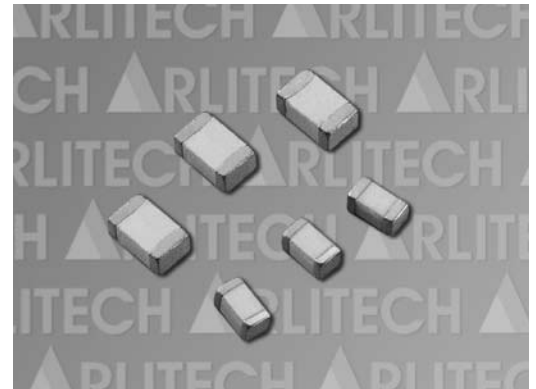

**Shape & Dimensions**

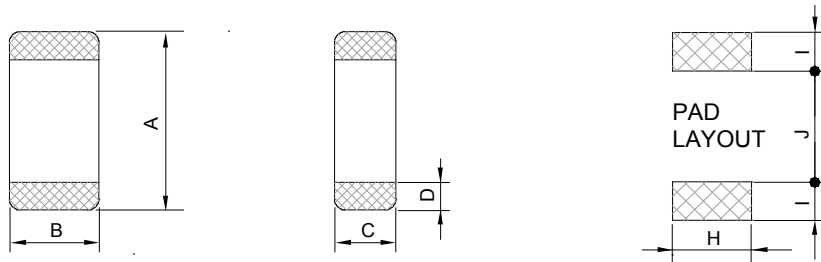

TYPE	A (mm)	B (mm)	C (mm)	D (mm)	H (Ref.)	I (Ref.)	J (Ref.)
AIF1005	1.0±0.1	0.5±0.1	0.5±0.1	0.25±0.1	0.4	0.5	0.4
AIF1608	1.6±0.2	0.8±0.2	0.8±0.2	0.3±0.2	0.8	1.0	0.6
AIF2012	2.0±0.2	1.25±0.2	0.9±0.2	0.5±0.3	1.0	1.0	1.0

**Product Identification**

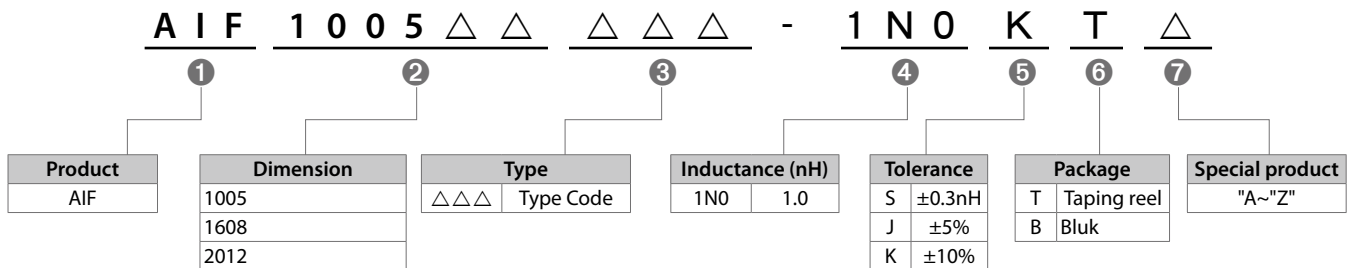

### Specification

Part Number	Inductance (H)	Inductance Tolerance	Q Min.	Test Freq. (MHz)	SRF (MHz)	DCR (Ω) Max.	Rated Current (mA) Max.
<b>AIF1005 Series Specification</b>							
AIF1005-1N0□T	1.0 n	S	8	100	10000	0.12	300
AIF1005-1N2□T	1.2 n	S	8	100	10000	0.12	300
AIF1005-1N5□T	1.5 n	S	8	100	6000	0.13	300
AIF1005-1N8□T	1.8 n	S	8	100	6000	0.14	300
AIF1005-2N2□T	2.2 n	S	8	100	6000	0.16	300
AIF1005-2N7□T	2.7 n	S	8	100	6000	0.17	300
AIF1005-3N3□T	3.3 n	S	8	100	6000	0.19	300
AIF1005-3N9□T	3.9 n	S	8	100	4000	0.22	300
AIF1005-4N7□T	4.7 n	S	8	100	4000	0.24	300
AIF1005-5N6□T	5.6 n	S	8	100	4000	0.27	300
AIF1005-6N8□T	6.8 n	J, K	8	100	3900	0.32	250
AIF1005-8N2□T	8.2 n	J, K	8	100	3600	0.37	250
AIF1005-10N□T	10 n	J, K	8	100	3200	0.42	250
AIF1005-12N□T	12 n	J, K	8	100	2700	0.50	250
AIF1005-15N□T	15 n	J, K	8	100	2300	0.55	250
AIF1005-18N□T	18 n	J, K	8	100	2100	0.65	200
AIF1005-22N□T	22 n	J, K	8	100	1900	0.80	200
AIF1005-27N□T	27 n	J, K	8	100	1600	0.90	200
AIF1005-33N□T	33 n	J, K	8	100	1300	1.00	200
AIF1005-39N□T	39 n	J, K	8	100	1200	1.20	150
AIF1005-47N□T	47 n	J, K	8	100	1000	1.30	150
AIF1005-56N□T	56 n	J, K	8	100	750	1.40	150
AIF1005-68N□T	68 n	J, K	8	100	750	1.40	150
AIF1005-82N□T	82 n	J, K	8	100	600	2.00	100
AIF1005-R10□T	100 n	J, K	8	100	600	2.00	100
<b>AIF1608 Series Specification</b>							
AIF1608-1N0□T	1.0 n	S	8	100	10000	0.05	300
AIF1608-1N2□T	1.2 n	S	8	100	10000	0.05	300
AIF1608-1N5□T	1.5 n	S	8	100	6000	0.10	300
AIF1608-1N8□T	1.8 n	S	8	100	6000	0.10	300
AIF1608-2N2□T	2.2 n	S	8	100	6000	0.10	300
AIF1608-2N7□T	2.7 n	S	10	100	6000	0.10	300
AIF1608-3N3□T	3.3 n	S	10	100	4000	0.12	300
AIF1608-3N9□T	3.9 n	S	10	100	3500	0.14	300
AIF1608-4N7□T	4.7 n	S	10	100	3500	0.16	300
AIF1608-5N6□T	5.6 n	S	10	100	3500	0.18	300
AIF1608-6N8□T	6.8 n	J, K	10	100	3000	0.22	300
AIF1608-8N2□T	8.2 n	J, K	10	100	3000	0.24	300
AIF1608-10N□T	10 n	J, K	12	100	2800	0.26	300
AIF1608-12N□T	12 n	J, K	12	100	2000	0.28	300
AIF1608-15N□T	15 n	J, K	12	100	2000	0.32	300
AIF1608-18N□T	18 n	J, K	12	100	1800	0.35	300
AIF1608-22N□T	22 n	J, K	12	100	1800	0.40	300
AIF1608-27N□T	27 n	J, K	12	100	1500	0.45	300
AIF1608-33N□T	33 n	J, K	12	100	1200	0.55	300
AIF1608-39N□T	39 n	J, K	12	100	1100	0.60	300
AIF1608-47N□T	47 n	J, K	12	100	900	0.70	300
AIF1608-56N□T	56 n	J, K	12	100	900	0.75	300
AIF1608-68N□T	68 n	J, K	12	100	700	0.85	300
AIF1608-82N□T	82 n	J, K	12	100	600	0.95	300
AIF1608-R10□T	100 n	J, K	12	100	600	1.00	300
AIF1608-R12□T	120 n	J, K	8	50	500	1.20	300
AIF1608-R15□T	150 n	J, K	8	50	500	1.20	300
AIF1608-R18□T	180 n	J, K	8	50	400	1.30	300
AIF1608-R22□T	220 n	J, K	8	50	400	1.50	300
AIF1608-R27□T	270 n	J, K	8	50	350	1.60	300

#### NOTE:

- The operating temperature range is -40°C to +85°C
- □ Tolerance S: ±0.3nH, J: ±5%, K: ±10%

### Specification

Part Number	Inductance (H)	Inductance Tolerance	Q Min.	Test Freq. (MHz)	SRF (MHz)	DCR ( $\Omega$ ) Max.	Rated Current (mA) Max.
<b>AIF2012 Series Specification</b>							
AIF2012-1N5□T	1.5 n	S	10	100	4000	0.10	300
AIF2012-1N8□T	1.8 n	S	10	100	4000	0.10	300
AIF2012-2N2□T	2.2 n	S	10	100	4000	0.10	300
AIF2012-2N7□T	2.7 n	S	12	100	4000	0.10	300
AIF2012-3N3□T	3.3 n	S	12	100	4000	0.13	300
AIF2012-3N9□T	3.9 n	S	12	100	3000	0.15	300
AIF2012-4N7□T	4.7 n	S	12	100	3000	0.20	300
AIF2012-5N6□T	5.6 n	S	15	100	3000	0.23	300
AIF2012-6N8□T	6.8 n	J, K	15	100	2500	0.25	300
AIF2012-8N2□T	8.2 n	J, K	15	100	2000	0.28	300
AIF2012-10N□T	10 n	J, K	15	100	2000	0.30	300
AIF2012-12N□T	12 n	J, K	15	100	1500	0.35	300
AIF2012-15N□T	15 n	J, K	15	100	1500	0.40	300
AIF2012-18N□T	18 n	J, K	15	100	1300	0.45	300
AIF2012-22N□T	22 n	J, K	18	100	1200	0.50	300
AIF2012-27N□T	27 n	J, K	18	100	1000	0.55	300
AIF2012-33N□T	33 n	J, K	18	100	1000	0.60	300
AIF2012-39N□T	39 n	J, K	18	100	800	0.65	300
AIF2012-47N□T	47 n	J, K	18	100	800	0.70	300
AIF2012-56N□T	56 n	J, K	18	100	700	0.75	300
AIF2012-68N□T	68 n	J, K	18	100	600	0.80	300
AIF2012-82N□T	82 n	J, K	18	100	500	0.90	300
AIF2012-R10□T	100 n	J, K	18	100	500	0.90	300

#### NOTE:

- The operating temperature range is -40°C to +85°C
- Tolerance S:  $\pm 0.3nH$ , J:  $\pm 5\%$ , K:  $\pm 10\%$

**Features**

- High performance ferrite cores that are designed to RC TYPE "Small Choke Coil" which can meet to the inductance value of 2.2uH.
- Small size and radial type.
- For high Q and Self-Resonant frequency.
- Designed by special lead wire to prevent open circuit failure

**Applications**

For switching regulators, switching power supplies, typewriters, amplifiers, monitors, TVs, uPSs, etc.

**Shape & Dimensions**

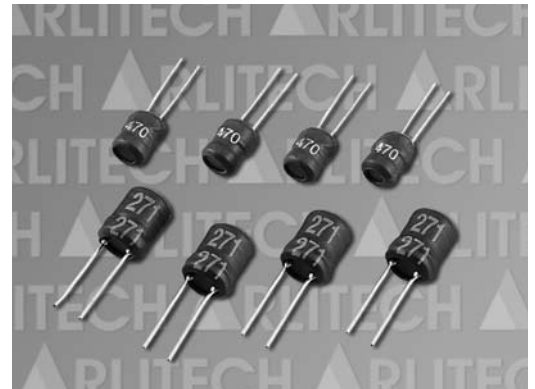
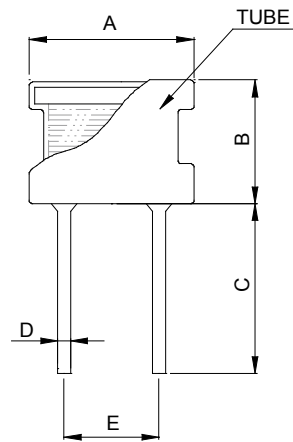

TYPE	A (mm)	B (mm)	C (mm)	D (mm)	E (mm)
ADR0608	8.5 MAX.	11.0 MAX.	10 MIN.	0.65±0.1	3.0±0.5
ADR0810	9.0+1.0	11.0+1.0	15±2.0	0.65±0.1	5.0±1.0
ADR0912	10.0+1.0	13.0+1.0	15±2.0	0.75±0.1	5.0±0.5

**Product Identification**

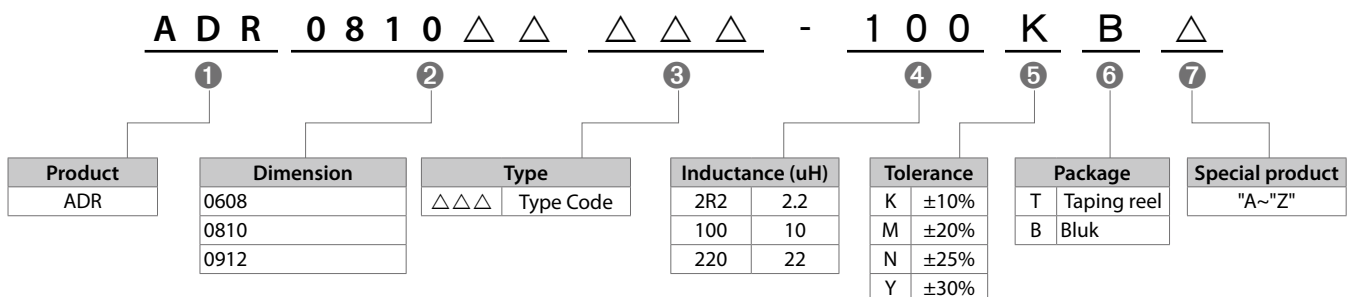

## Specification

Part Number	Inductance (H)	Q Min.	Test Freq. (MHz)	SRF(MHz) Min.	DCR (Ω) Max.	Rated Current (mA) Max.
<b>ADR0608 Series Specification</b>						
ADR0608-1R0□B	1.0u	60	1.0	105	0.20	1030.0
ADR0608-1R2□B	1.2u	60	1.0	90	0.25	980.0
ADR0608-1R5□B	1.5u	60	1.0	75	0.25	920.0
ADR0608-2R2□B	2.2u	60	1.0	65	0.25	830.0
ADR0608-2R7□B	2.7u	60	1.0	60	0.30	790.0
ADR0608-3R3□B	3.3u	60	1.0	50	0.30	750.0
ADR0608-3R9□B	3.9u	60	1.0	45	0.30	720.0
ADR0608-4R7□B	4.7u	60	1.0	40	0.35	670.0
ADR0608-5R6□B	5.6u	60	1.0	35	0.35	640.0
ADR0608-6R8□B	6.8u	60	1.0	30	0.40	620.0
ADR0608-8R2□B	8.2u	60	1.0	25	0.40	590.0
ADR0608-100□B	10u	60	1.0	20	0.45	550.0
ADR0608-120□B	12u	60	1.0	15	0.50	530.0
ADR0608-150□B	15u	60	1.0	13	0.55	500.0
ADR0608-180□B	18u	60	1.0	11	0.60	480.0
ADR0608-220□B	22u	60	1.0	10	0.65	460.0
ADR0608-270□B	27u	50	1.0	9	0.75	430.0
ADR0608-330□B	33u	50	1.0	8	0.85	410.0
ADR0608-390□B	39u	50	1.0	7.5	0.90	390.0
ADR0608-470□B	47u	50	1.0	7	1.00	370.0
ADR0608-560□B	56u	50	1.0	6.5	1.20	350.0
ADR0608-680□B	68u	50	1.0	6	1.30	340.0
ADR0608-820□B	82u	50	1.0	5.5	1.50	320.0
ADR0608-101□B	100u	50	1.0	5	1.70	305.0
ADR0608-121□B	120u	50	1.0	4.8	1.90	290.0
ADR0608-151□B	150u	50	1.0	4.4	2.10	275.0
ADR0608-181□B	180u	50	1.0	4.2	2.30	185.0
ADR0608-221□B	220u	45	1.0	3.8	2.50	175.0
ADR0608-271□B	270u	45	1.0	3.6	2.75	165.0
ADR0608-331□B	330u	45	1.0	3.3	4.68	155.0
ADR0608-391□B	390u	45	1.0	3	6.00	145.0
ADR0608-471□B	470u	55	1.0	2.8	6.50	140.0
ADR0608-561□B	560u	55	1.0	2.4	8.50	135.0
ADR0608-681□B	680u	55	1.0	2.2	9.00	125.0
ADR0608-821□B	820u	55	1.0	2	9.60	120.0
<b>ADR0810 Series Specification</b>						
ADR0810-102□B	1.0m	65	1.0	1.40	6.00	58.00
ADR0810-122□B	1.2m	140	1.0	1.20	6.00	58.00
ADR0810-152□B	1.5m	130	1.0	1.10	7.00	58.00
ADR0810-162□B	1.6m	150	1.0	1.10	10.00	55.00
ADR0810-182□B	1.8m	150	1.0	1.10	10.00	55.00
ADR0810-222□B	2.2m	150	1.0	1.00	12.00	33.00
ADR0810-272□B	2.7m	140	1.0	0.90	14.00	33.00
ADR0810-302□B	3.0m	140	1.0	0.90	15.00	29.00
ADR0810-332□B	3.3m	140	1.0	0.86	16.00	29.00
ADR0810-392□B	3.9m	130	1.0	0.81	18.00	29.00
ADR0810-472□B	4.7m	120	1.0	0.77	20.00	20.00
ADR0810-562□B	5.6m	120	1.0	0.72	22.00	20.00
ADR0810-682□B	6.8m	110	1.0	0.54	29.00	20.00
ADR0810-752□B	7.5m	110	1.0	0.52	30.00	20.00
ADR0810-822□B	8.2m	110	1.0	0.50	30.00	20.00
<b>ADR0912 Series Specification</b>						
ADR0912-103□B	10m	140	L (1) / Q (79)	0.35	12.00	37.00
ADR0912-123□B	12m	140	L (1) / Q (79)	0.31	13.00	37.00
ADR0912-153□B	15m	140	L (1) / Q (79)	0.28	18.00	30.00
ADR0912-183□B	18m	130	L (1) / Q (79)	0.26	25.00	30.00
ADR0912-223□B	22m	130	L (1) / Q (79)	0.22	30.00	17.00
ADR0912-273□B	27m	130	L (1) / Q (79)	0.20	35.00	17.00
ADR0912-333□B	33m	110	L (1) / Q (79)	0.19	40.00	17.00
ADR0912-393□B	39m	110	L (1) / Q (79)	0.17	50.00	13.00
ADR0912-473□B	47m	110	L (1) / Q (79)	0.15	50.00	18.00
ADR0912-563□B	56m	100	L (1) / Q (79)	0.13	65.00	18.00
ADR0912-683□B	68m	80	L (1) / Q (79)	0.12	70.00	8.00
ADR0912-823□B	82m	65	L (1) / Q (79)	0.10	85.00	8.00
ADR0912-104□B	100m	60	L (1) / Q (79)	0.10	100.00	8.00

### NOTE:

- The operating temperature range is -25°C to +85°C
- □ Tolerance K: ±10%, M: ±20%